

TOSHIBA MOS DIGITAL INTEGRATED CIRCUIT SILICON GATE CMOS

## 1 GBIT (128M × 8 BIT) CMOS NAND E<sup>2</sup>PROM

### DESCRIPTION

The TC58NVG0S3E is a single 3.3V 1 Gbit (1,107,296,256 bits) NAND Electrically Erasable and Programmable Read-Only Memory (NAND E<sup>2</sup>PROM) organized as (2048 + 64) bytes × 64 pages × 1024 blocks. The device has two 2112-byte static registers which allow program and read data to be transferred between the register and the memory cell array in 2112-byte increments. The Erase operation is implemented in a single block unit (128 Kbytes + 4 Kbytes: 2112 bytes × 64 pages).

The TC58NVG0S3E is a serial-type memory device which utilizes the I/O pins for both address and data input/output as well as for command inputs. The Erase and Program operations are automatically executed making the device most suitable for applications such as solid-state file storage, voice recording, image file memory for still cameras and other systems which require high-density non-volatile memory data storage.

### FEATURES

- Organization
 

Memory cell array	x8	2112 × 64K × 8
Register		2112 × 8
Page size		2112 bytes
Block size		(128K + 4K) bytes
- Modes
 

Read, Reset, Auto Page Program, Auto Block Erase, Status Read, Page Copy, Multi Page Program, Multi Block Erase, Multi Page Copy, Multi Page Read
- Mode control
 

Serial input/output  
Command control
- Number of valid blocks
 

Min 1004 blocks  
Max 1024 blocks
- Power supply
 

VCC = 2.7V to 3.6V
- Access time
 

Cell array to register	25 μs max
Serial Read Cycle	25 ns min (CL=100pF)
- Program/Erase time
 

Auto Page Program	300 μs/page typ.
Auto Block Erase	2.5 ms/block typ.
- Operating current
 

Read (25 ns cycle)	30 mA max.
Program (avg.)	30 mA max
Erase (avg.)	30 mA max
Standby	50 μA max
- Package
 

TSOP I 48-P-1220-0.50 (Weight: 0.53 g typ.)

SKYTECH

تهیه و توزیع قطعات الکترونیک

**PIN ASSIGNMENT (TOP VIEW)**

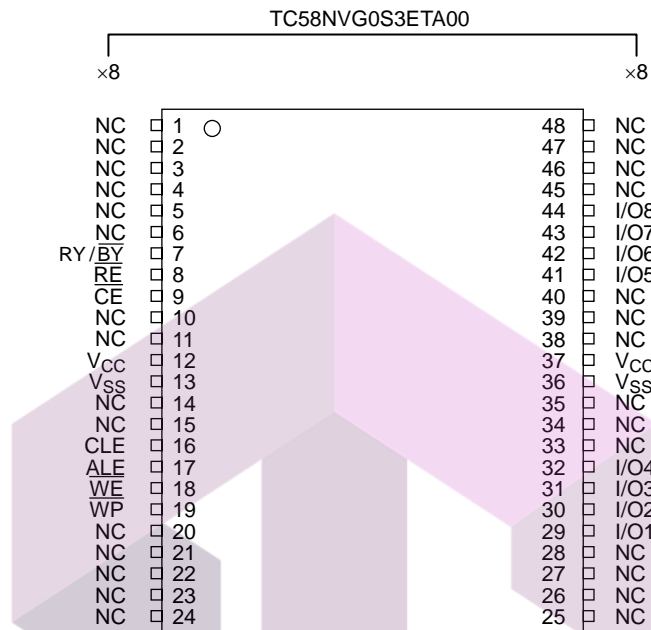

**PIN NAMES**

I/O1 to I/O8	I/O port
$\overline{CE}$	Chip enable
$\overline{WE}$	Write enable
$\overline{RE}$	Read enable
CLE	Command latch enable
ALE	Address latch enable
$\overline{WP}$	Write protect
RY/BY	Ready/Busy
V <sub>CC</sub>	Power supply
V <sub>SS</sub>	Ground

SKYTECH

تهیه و توزیع قطعات الکترونیک

**BLOCK DIAGRAM**

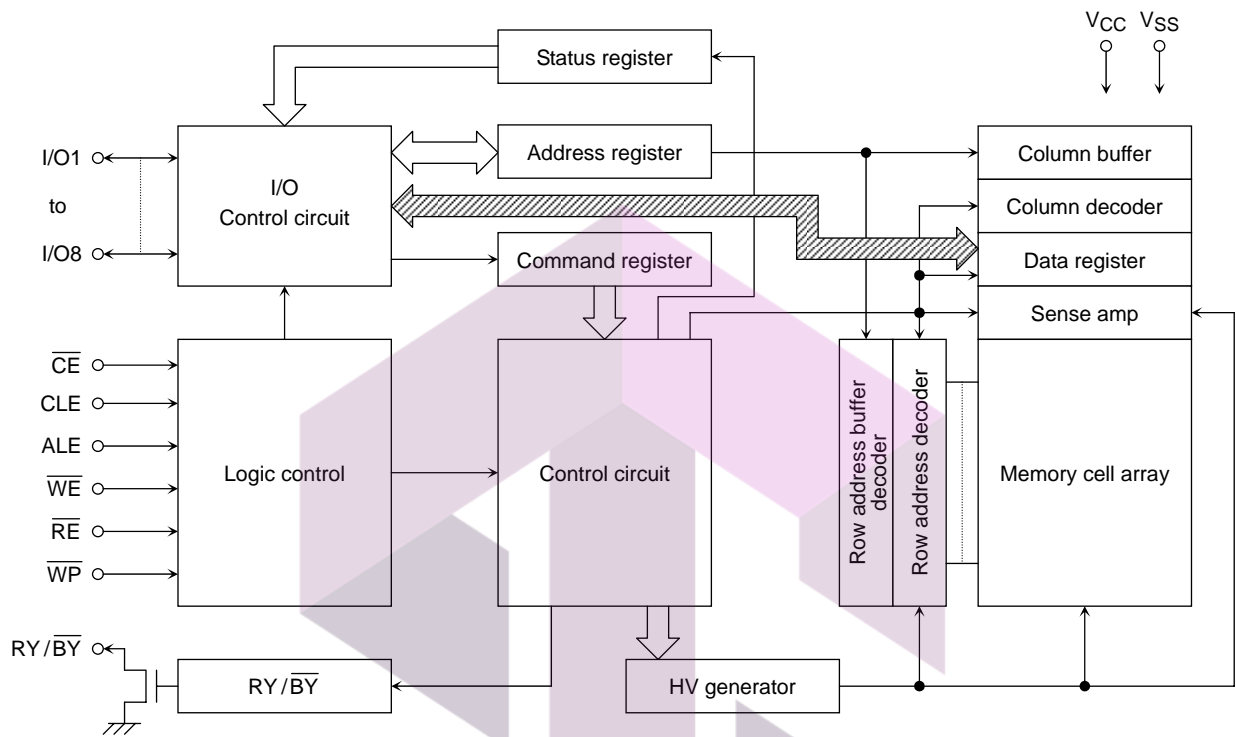

**ABSOLUTE MAXIMUM RATINGS**

SYMBOL	RATING	VALUE	UNIT
V <sub>CC</sub>	Power Supply Voltage	-0.6 to 4.6	V
V <sub>IN</sub>	Input Voltage	-0.6 to 4.6	V
V <sub>I/O</sub>	Input /Output Voltage	-0.6 to V <sub>CC</sub> + 0.3 (≤ 4.6 V)	V
P <sub>D</sub>	Power Dissipation	0.3	W
T <sub>SOLDER</sub>	Soldering Temperature (10 s)	260	°C
T <sub>STG</sub>	Storage Temperature	-55 to 150	°C
T <sub>OPR</sub>	Operating Temperature	0 to 70	°C

**CAPACITANCE** \*(T<sub>a</sub> = 25°C, f = 1 MHz)

SYMBOL	PARAMETER	CONDITION	MIN	MAX	UNIT
C <sub>IN</sub>	Input	V <sub>IN</sub> = 0 V	—	10	pF
C <sub>OUT</sub>	Output	V <sub>OUT</sub> = 0 V	—	10	pF

\* This parameter is periodically sampled and is not tested for every device.

## VALID BLOCKS

SYMBOL	PARAMETER	MIN	TYP.	MAX	UNIT
N <sub>VB</sub>	Number of Valid Blocks	1004	—	1024	Blocks

NOTE: The device occasionally contains unusable blocks. Refer to Application Note (13) toward the end of this document.

The first block (Block 0) is guaranteed to be a valid block at the time of shipment.

The specification for the minimum number of valid blocks is applicable over lifetime

The number of valid blocks is on the basis of single plane operations, and this may be decreased with two plane operations.

## RECOMMENDED DC OPERATING CONDITIONS

SYMBOL	PARAMETER		MIN	TYP.	MAX	UNIT
V <sub>CC</sub>	Power Supply Voltage		2.7	—	3.6	V
V <sub>IH</sub>	High Level input Voltage	$2.7\text{ V} \leq V_{CC} \leq 3.6\text{ V}$	$V_{CC} \times 0.8$	—	$V_{CC} + 0.3$	V
V <sub>IL</sub>	Low Level Input Voltage	$2.7\text{ V} \leq V_{CC} \leq 3.6\text{ V}$	-0.3*	—	$V_{CC} \times 0.2$	V

\* -2 V (pulse width lower than 20 ns)

## DC CHARACTERISTICS (T<sub>a</sub> = 0 to 70 °C, V<sub>CC</sub> = 2.7 to 3.6V)

SYMBOL	PARAMETER	CONDITION	MIN	TYP.	MAX	UNIT
I <sub>IL</sub>	Input Leakage Current	V <sub>IN</sub> = 0 V to V <sub>CC</sub>	—	—	±10	μA
I <sub>LO</sub>	Output Leakage Current	V <sub>OUT</sub> = 0 V to V <sub>CC</sub>	—	—	±10	μA
I <sub>CCO1</sub>	Serial Read Current	$\overline{CE} = V_{IL}, I_{OUT} = 0\text{ mA}, t_{cycle} = 25\text{ ns}$	—	—	30	mA
I <sub>CCO2</sub>	Programming Current	—	—	—	30	mA
I <sub>CCO3</sub>	Erasing Current	—	—	—	30	mA
I <sub>CCS</sub>	Standby Current	$\overline{CE} = V_{CC} - 0.2\text{ V}, \overline{WP} = 0\text{ V}/V_{CC}$	—	—	50	μA
V <sub>OH</sub>	High Level Output Voltage	I <sub>OH</sub> = -0.1 mA	V <sub>CC</sub> - 0.2	—	—	V
V <sub>OL</sub>	Low Level Output Voltage	I <sub>OL</sub> = 0.1 mA	—	—	0.2	V
I <sub>OL</sub> (R <sub>Y</sub> / $\overline{BY}$ )	Output current of R <sub>Y</sub> / $\overline{BY}$ pin	V <sub>OL</sub> = 0.2 V	—	4	—	mA

تهیه و توزیع قطعات الکترونیک

## AC CHARACTERISTICS AND RECOMMENDED OPERATING CONDITIONS

(Ta = 0 to 70 , Vcc = 2.7 to 3.6V)

SYMBOL	PARAMETER	MIN	MAX	UNIT
tCLS	CLE Setup Time	12	—	ns
tCLH	CLE Hold Time	5	—	ns
tCS	$\overline{CE}$ Setup Time	20	—	ns
tCH	$\overline{CE}$ Hold Time	5	—	ns
tWP	Write Pulse Width	12	—	ns
tALS	ALE Setup Time	12	—	ns
tALH	ALE Hold Time	5	—	ns
tDS	Data Setup Time	12	—	ns
tDH	Data Hold Time	5	—	ns
tWC	Write Cycle Time	25	—	ns
tWH	$\overline{WE}$ High Hold Time	10	—	ns
tWW	$\overline{WP}$ High to $\overline{WE}$ Low	100	—	ns
tRR	Ready to $\overline{RE}$ Falling Edge	20	—	ns
tRW	Ready to $\overline{WE}$ Falling Edge	20	—	ns
tRP	Read Pulse Width	12	—	ns
tRC	Read Cycle Time	25	—	ns
tREA	$\overline{RE}$ Access Time	—	20	ns
tCEA	$\overline{CE}$ Access Time	—	25	ns
tCLR	CLE Low to $\overline{RE}$ Low	10	—	ns
tAR	ALE Low to $\overline{RE}$ Low	10	—	ns
tRHOH	$\overline{RE}$ High to Output Hold Time	22	—	ns
tRLOH	$\overline{RE}$ Low to Output Hold Time	5	—	ns
tRHZ	$\overline{RE}$ High to Output High Impedance	—	60	ns
tCHZ	$\overline{CE}$ High to Output High Impedance	—	20	ns
tCSD	$\overline{CE}$ High to ALE or CLE Don't Care	0	—	ns
tREH	$\overline{RE}$ High Hold Time	10	—	ns
tIR	Output-High-impedance-to- $\overline{RE}$ Falling Edge	0	—	ns
tRHW	$\overline{RE}$ High to $\overline{WE}$ Low	30	—	ns
tWHC	$\overline{WE}$ High to $\overline{CE}$ Low	30	—	ns
tWHR	$\overline{WE}$ High to $\overline{RE}$ Low	60	—	ns
tR	Memory Cell Array to Starting Address	—	25	μs
tDCBSYR1	Data Cache Busy in Read Cache (following 31h and 3Fh)	—	30	μs
tDCBSYR2	Data Cache Busy in Page Copy (following 3Ah)	—	35	μs
tWB	$\overline{WE}$ High to Busy	—	100	ns
tRST	Device Reset Time (Ready/Read/Program/Erase)	—	6/6/10/500	μs

\*1: tCLS and tALS can not be shorter than tWP

\*2: tCS should be longer than tWP + 8ns.

**AC TEST CONDITIONS**

PARAMETER	CONDITION
	$V_{CC}: 2.7 \text{ to } 3.6V$
Input level	$V_{CC} - 0.2 V, 0.2 V$
Input pulse rise and fall time	3 ns
Input comparison level	$V_{CC} / 2$
Output data comparison level	$V_{CC} / 2$
Output load	$C_L (100 \text{ pF}) + 1 \text{ TTL}$

Note: Busy to ready time depends on the pull-up resistor tied to the  $\overline{RY}/\overline{BY}$  pin.  
(Refer to Application Note (9) toward the end of this document.)

**PROGRAMMING AND ERASING CHARACTERISTICS**

( $T_a = 0 \text{ to } 70$  ,  $V_{CC} = 2.7 \text{ to } 3.6V$ )

SYMBOL	PARAMETER	MIN	TYP.	MAX	UNIT	NOTES
$t_{PROG}$	Average Programming Time	—	300	700	$\mu s$	
$t_{DCBSYW1}$	Data Cache Busy Time in Write Cache (following 11h)	—	—	10	$\mu s$	
$t_{DCBSYW2}$	Data Cache Busy Time in Write Cache (following 15h)	—	—	700	$\mu s$	(2)
N	Number of Partial Program Cycles in the Same Page	—	—	4		(1)
$t_{BERASE}$	Block Erasing Time	—	2.5	10	ms	

(1) Refer to Application Note (12) toward the end of this document.

(2)  $t_{DCBSYW2}$  depends on the timing between internal programming time and data in time.

**Data Output**

When  $t_{REH}$  is long, output buffers are disabled by  $/RE=High$ , and the hold time of data output depend on  $t_{RHOH}$  (25ns MIN). On this condition, waveforms look like normal serial read mode.

When  $t_{REH}$  is short, output buffers are not disabled by  $/RE=High$ , and the hold time of data output depend on  $t_{RLOH}$  (5ns MIN). On this condition, output buffers are disabled by the rising edge of  $CLE, ALE, /CE$  or falling edge of  $/WE$ , and waveforms look like Extended Data Output Mode.

تهیه و توزیع قطعات الکترونیک

**TIMING DIAGRAMS**

Latch Timing Diagram for Command/Address/Data

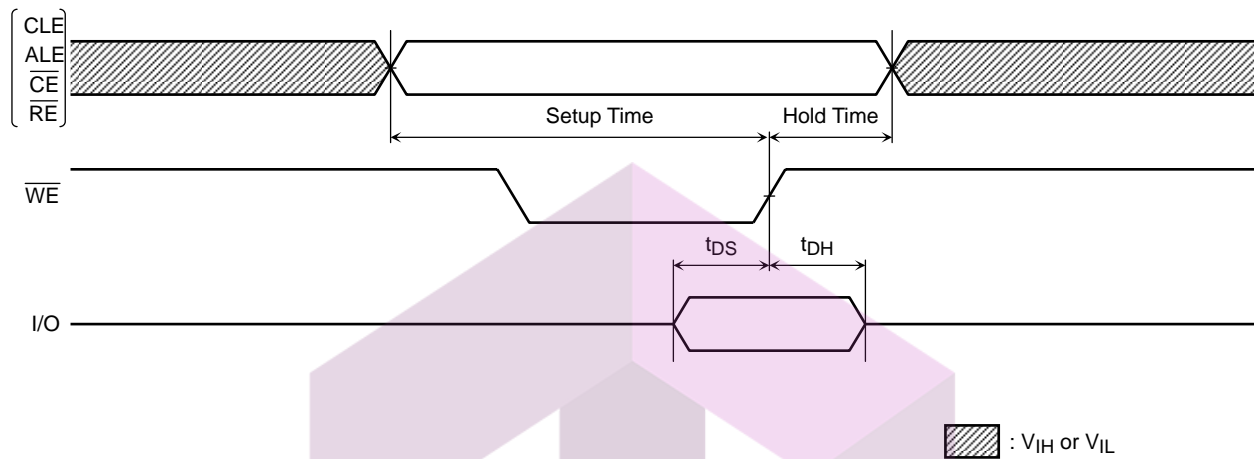

Command Input Cycle Timing Diagram

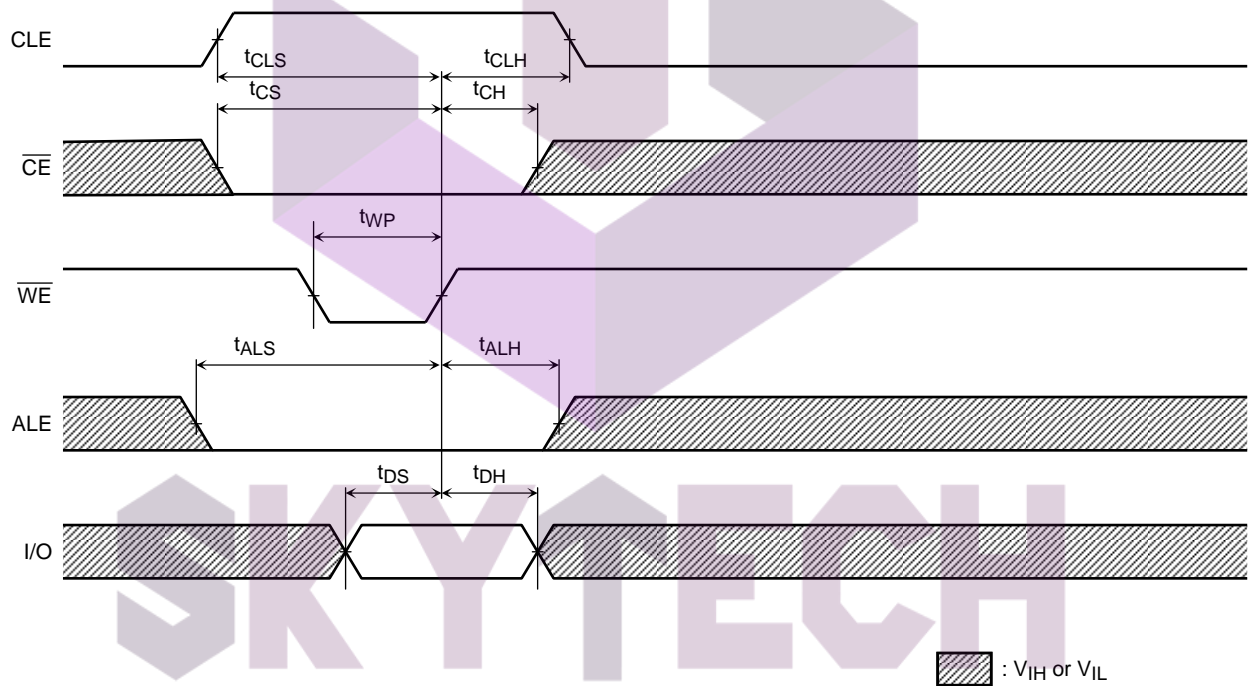

تهیه و توزیع قطعات الکترونیک

Address Input Cycle Timing Diagram

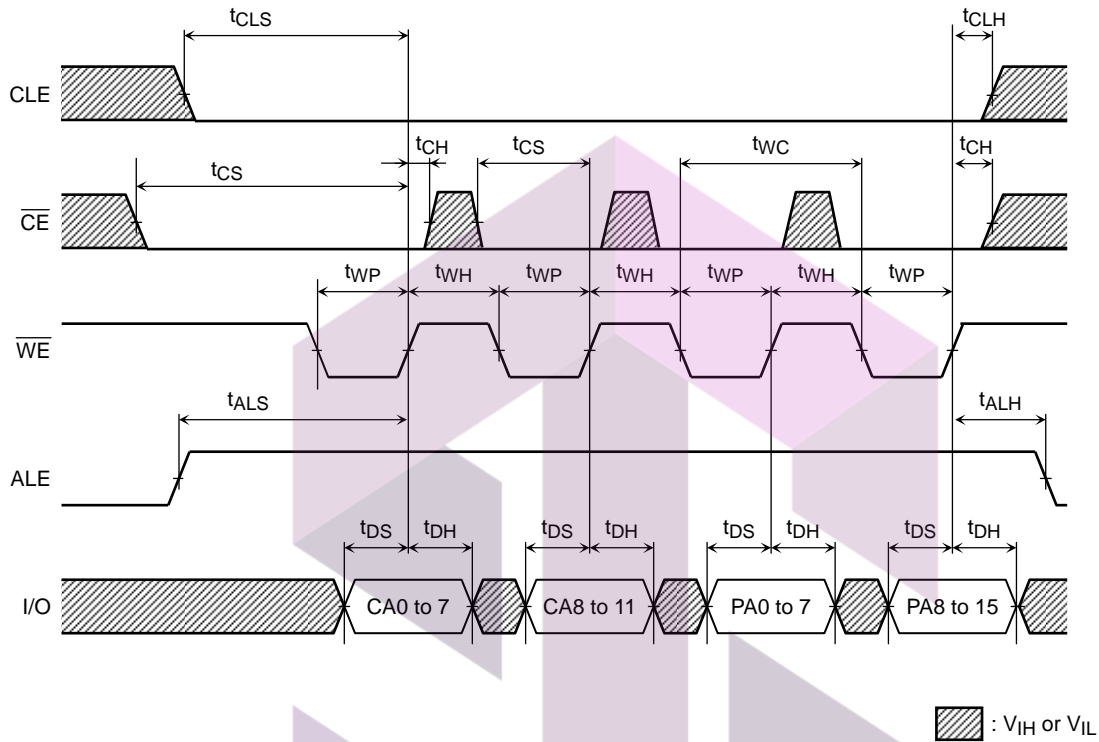

Data Input Cycle Timing Diagram

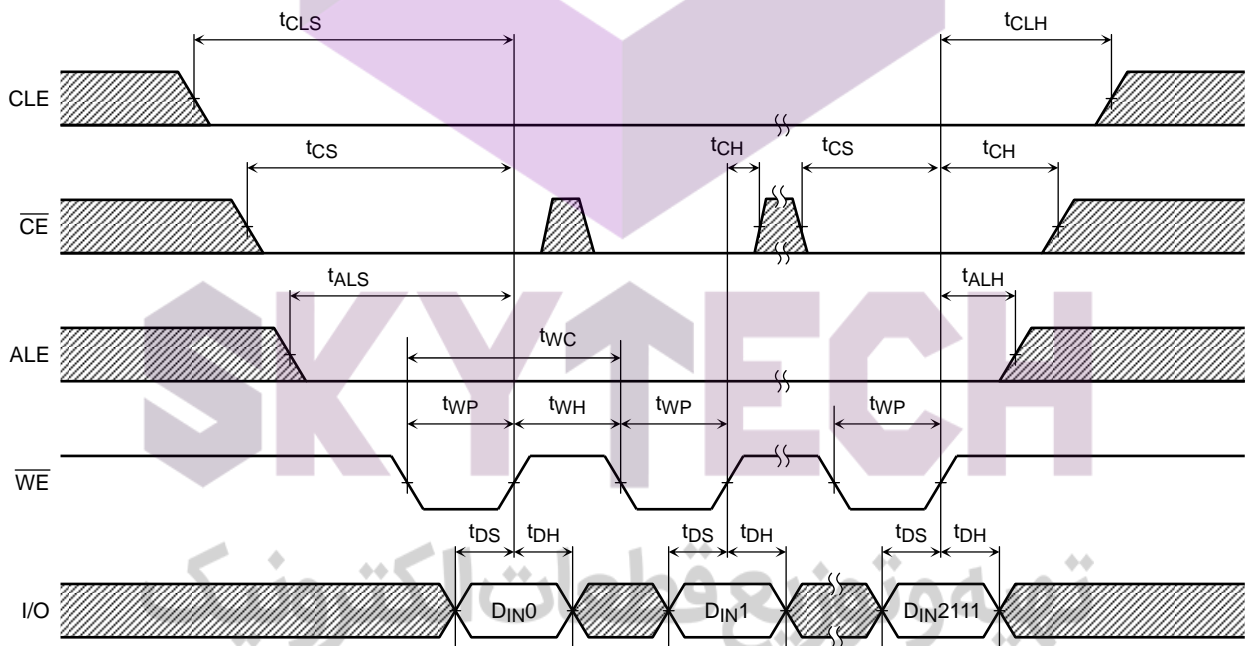



Serial Read Cycle Timing Diagram

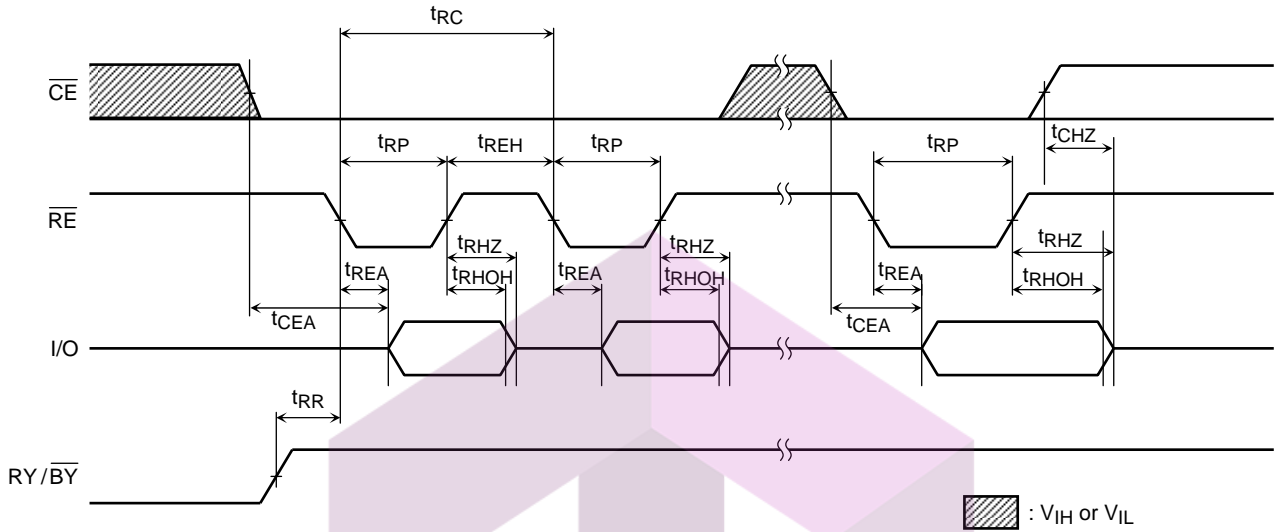

Status Read Cycle Timing Diagram

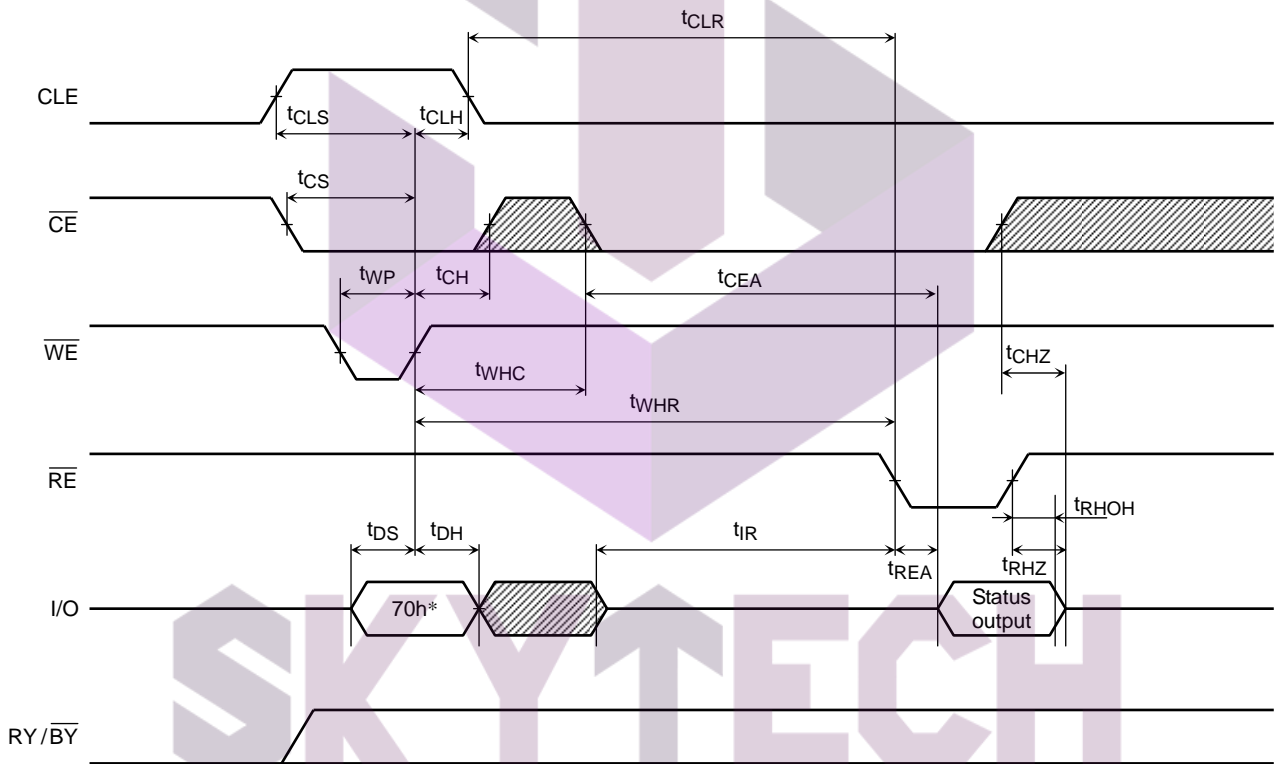

\*: 70h represents the hexadecimal number

▨ :  $V_{IH}$  or  $V_{IL}$

Read Cycle Timing Diagram

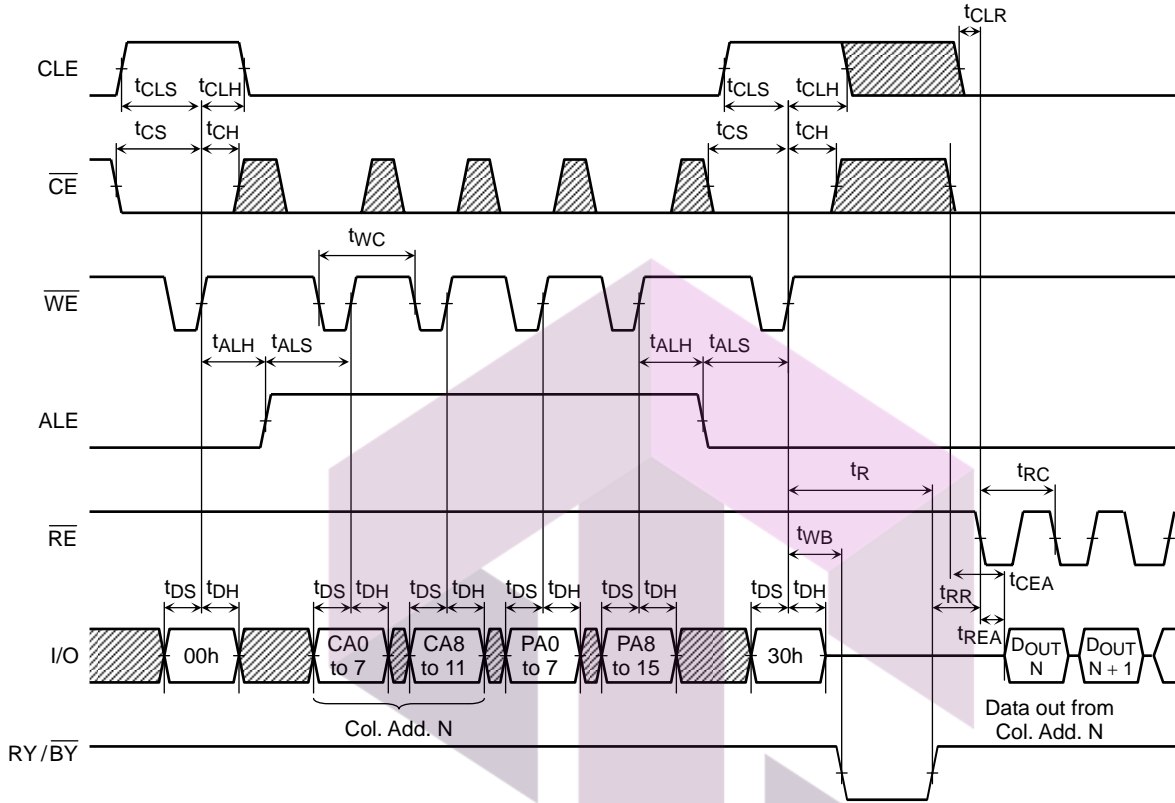

Read Cycle Timing Diagram: When Interrupted by  $\overline{CE}$

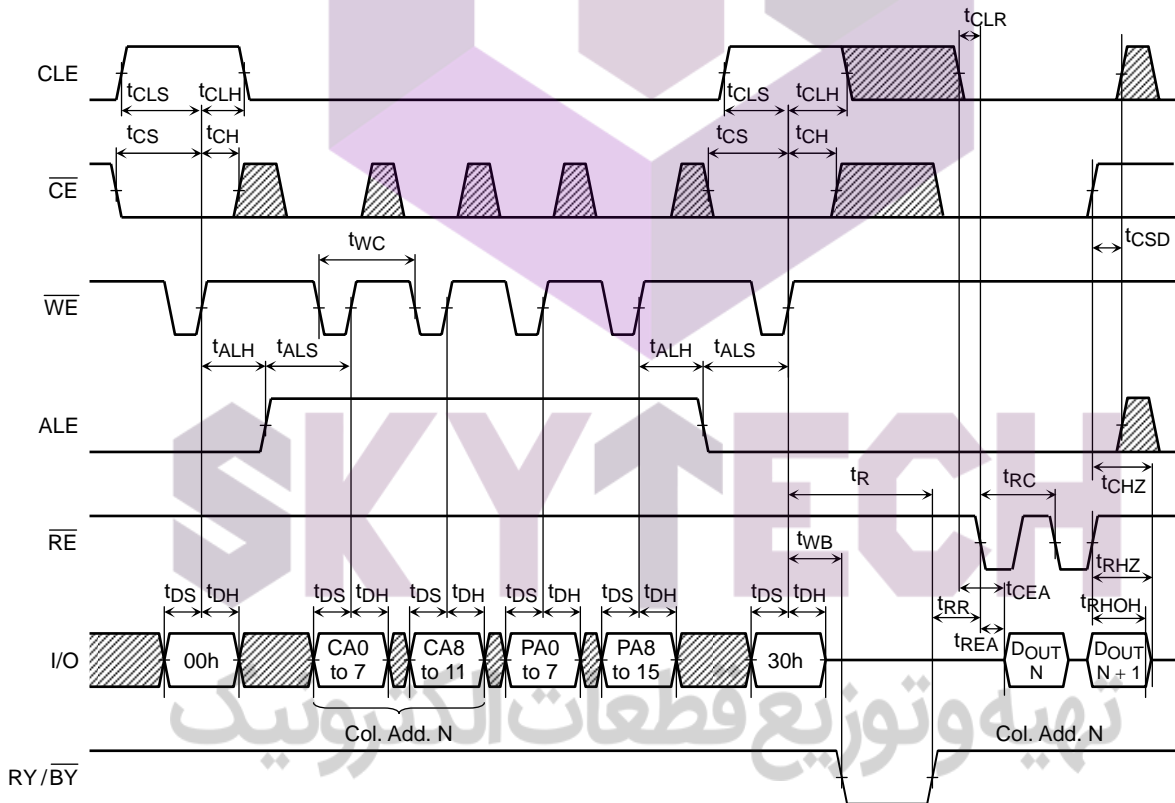

Read Cycle with Data Cache Timing Diagram (1/2)

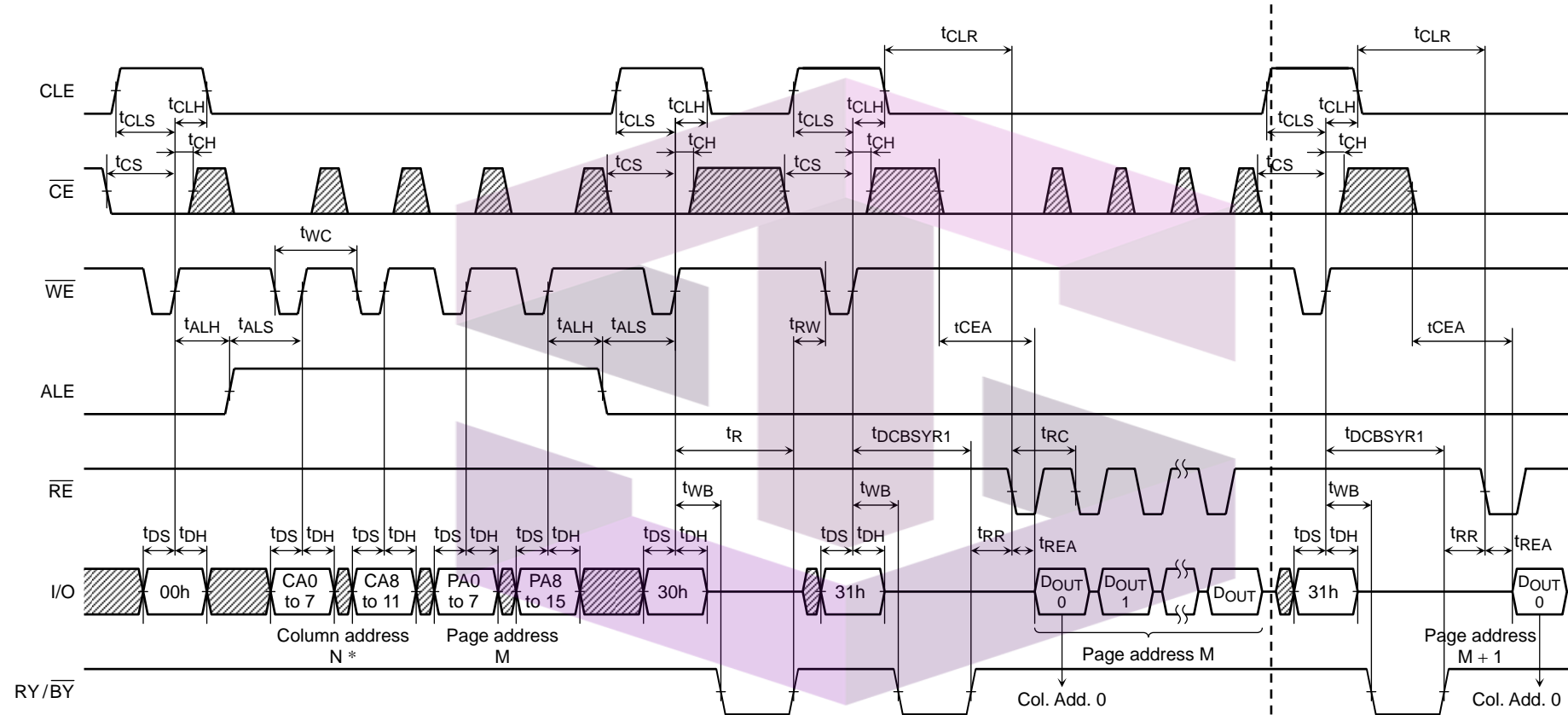

\* The column address will be reset to 0 by the 31h command input.

Continues to 1 of next page



Read Cycle with Data Cache Timing Diagram (2/2)

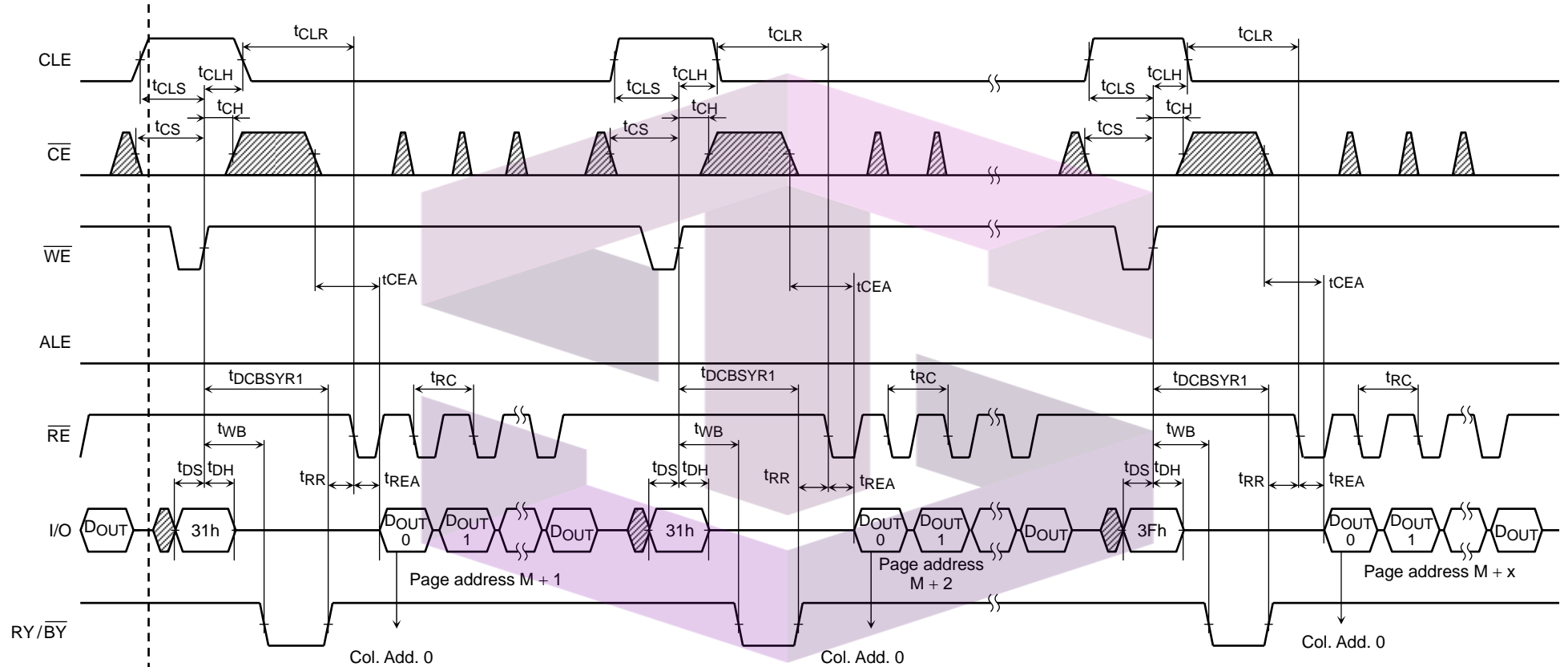

1

Continues from 1 of last page

Make sure to terminate the operation with 3Fh command.



تهیه و توزیع قطعات الکترونیک

Column Address Change in Read Cycle Timing Diagram (1/2)

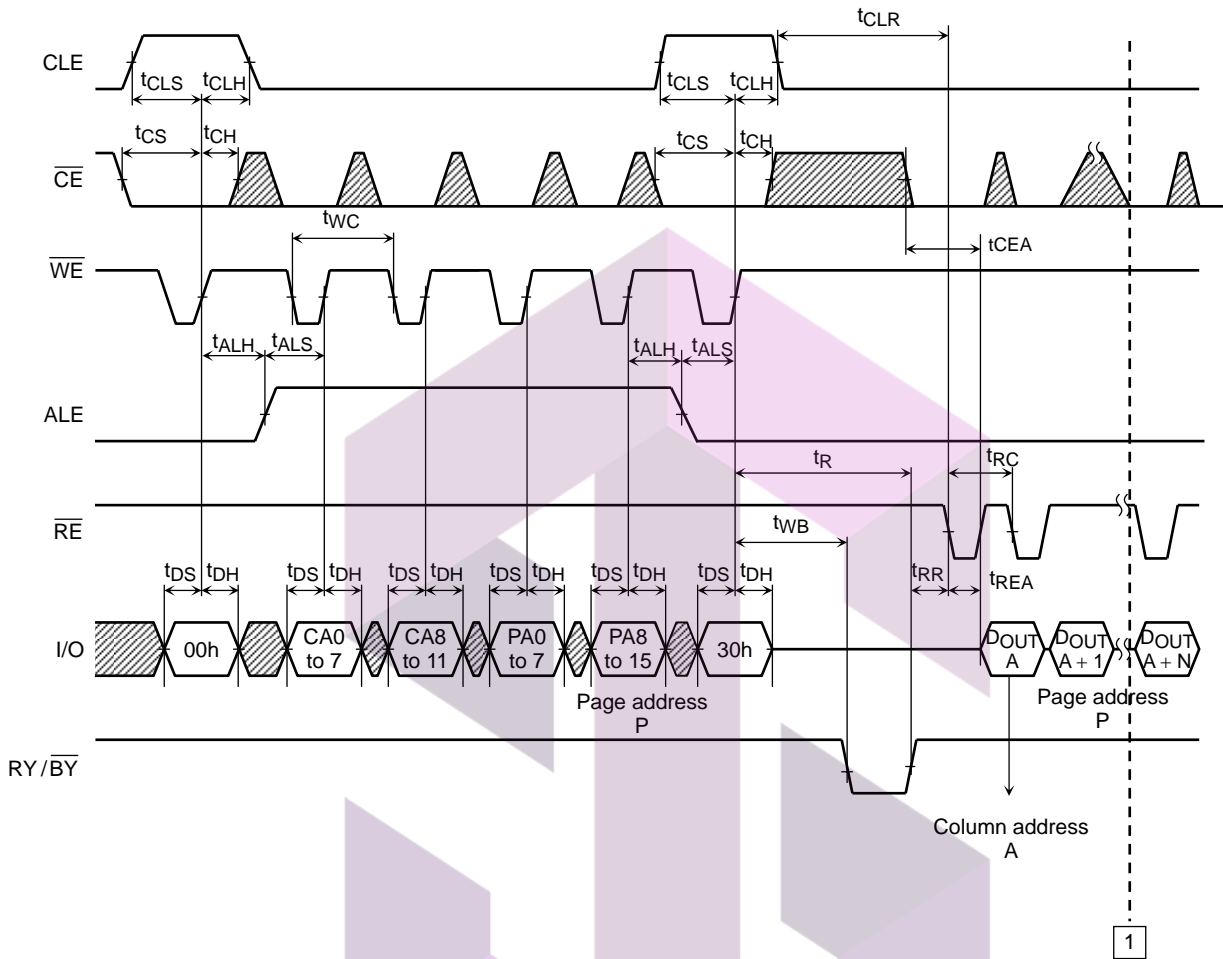

Continues from 1 of next page

SKYTECH

تهیه و توزیع قطعات الکترونیک

Column Address Change in Read Cycle Timing Diagram (2/2)

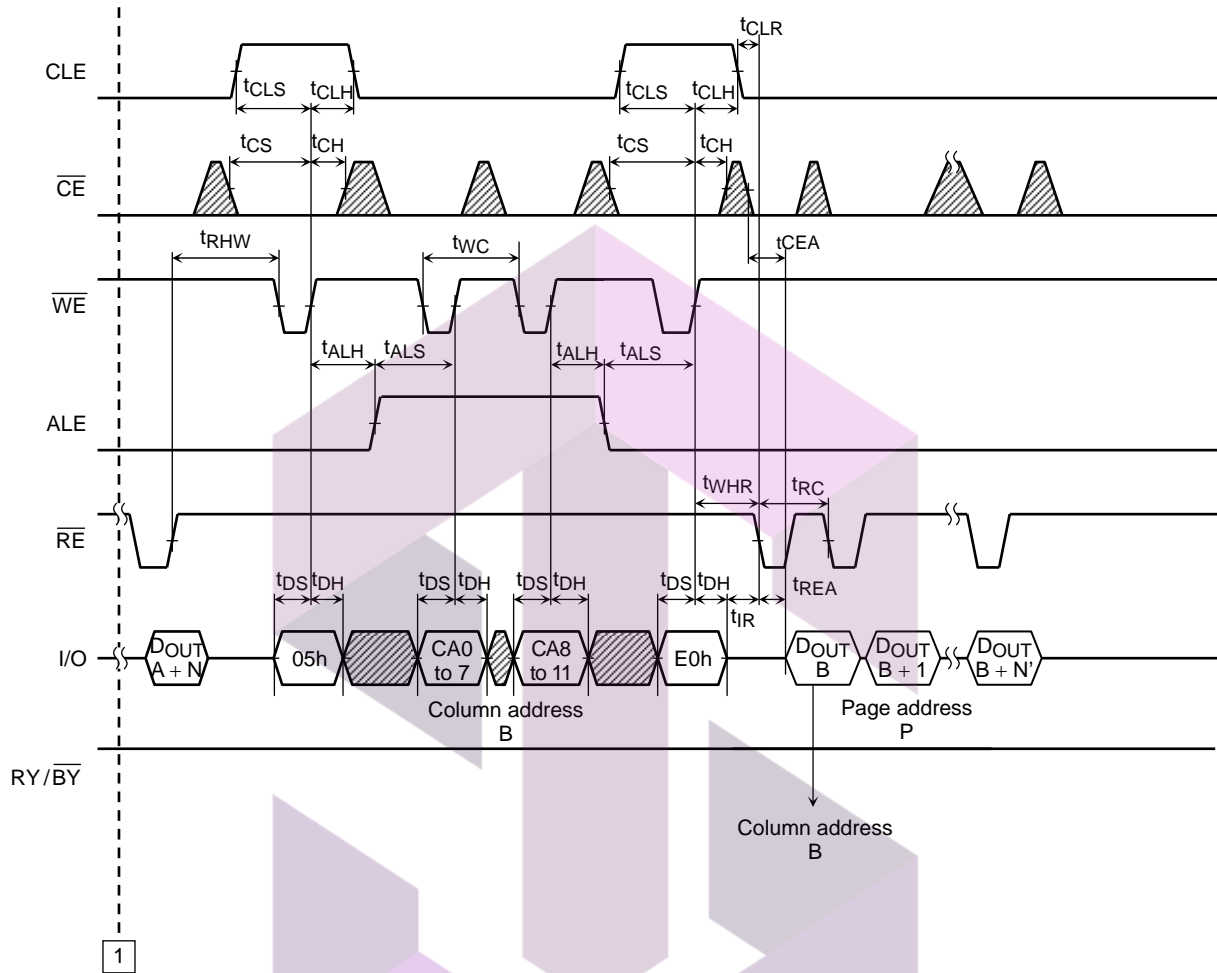

Continues from 1 of last page

SKYTECH

تهیه و توزیع قطعات الکترونیک

Data Output Timing Diagram

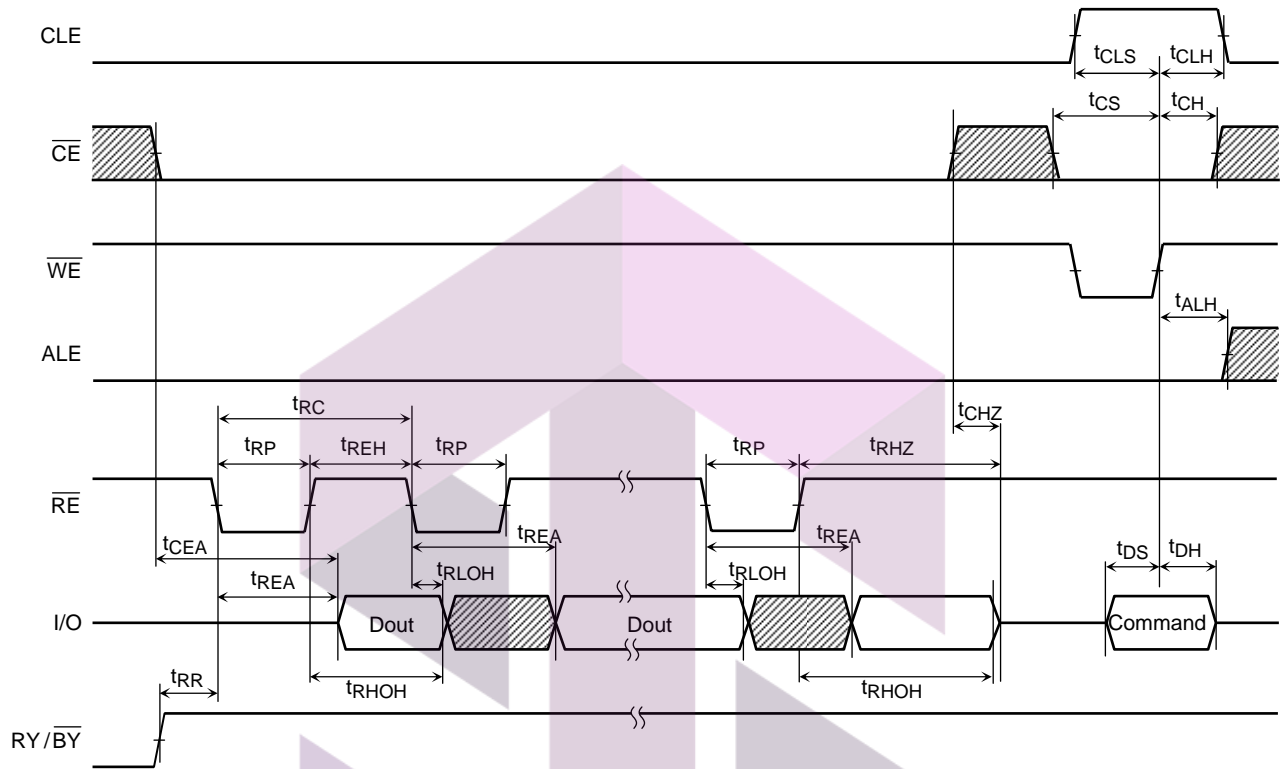



SKYTECH

تهیه و توزیع قطعات الکترونیک

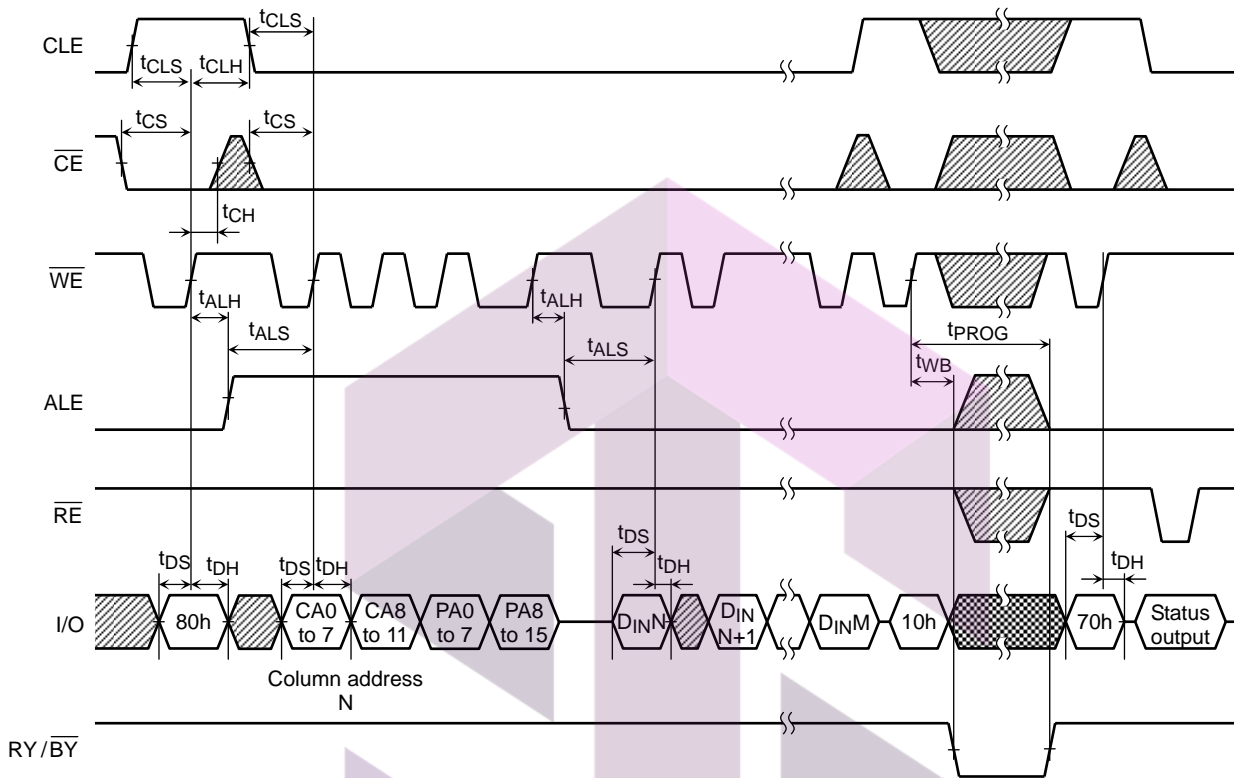
Auto-Program Operation Timing Diagram



 : Do not input data while data is being output.  
 :  $V_{IH}$  or  $V_{IL}$

\*) M: up to 2112 (byte input data for  $\times 8$  device).

**SKYTECH**

تهیه و توزیع قطعات الکترونیک



Auto-Program Operation with Data Cache Timing Diagram (1/3)

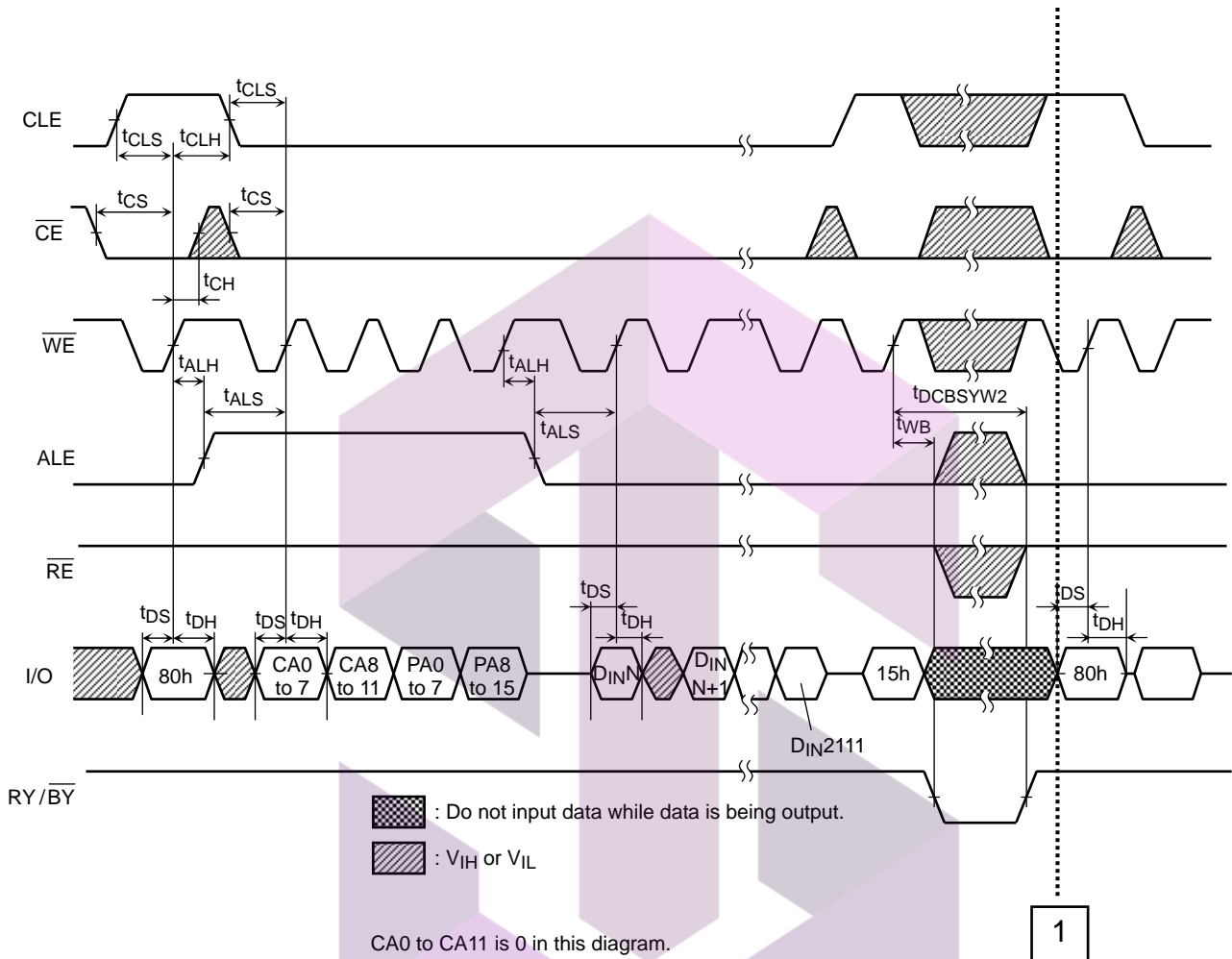

Continues to 1 of next page

SKYTECH

تهیه و توزیع قطعات الکترونیک

Auto-Program Operation with Data Cache Timing Diagram (2/3)

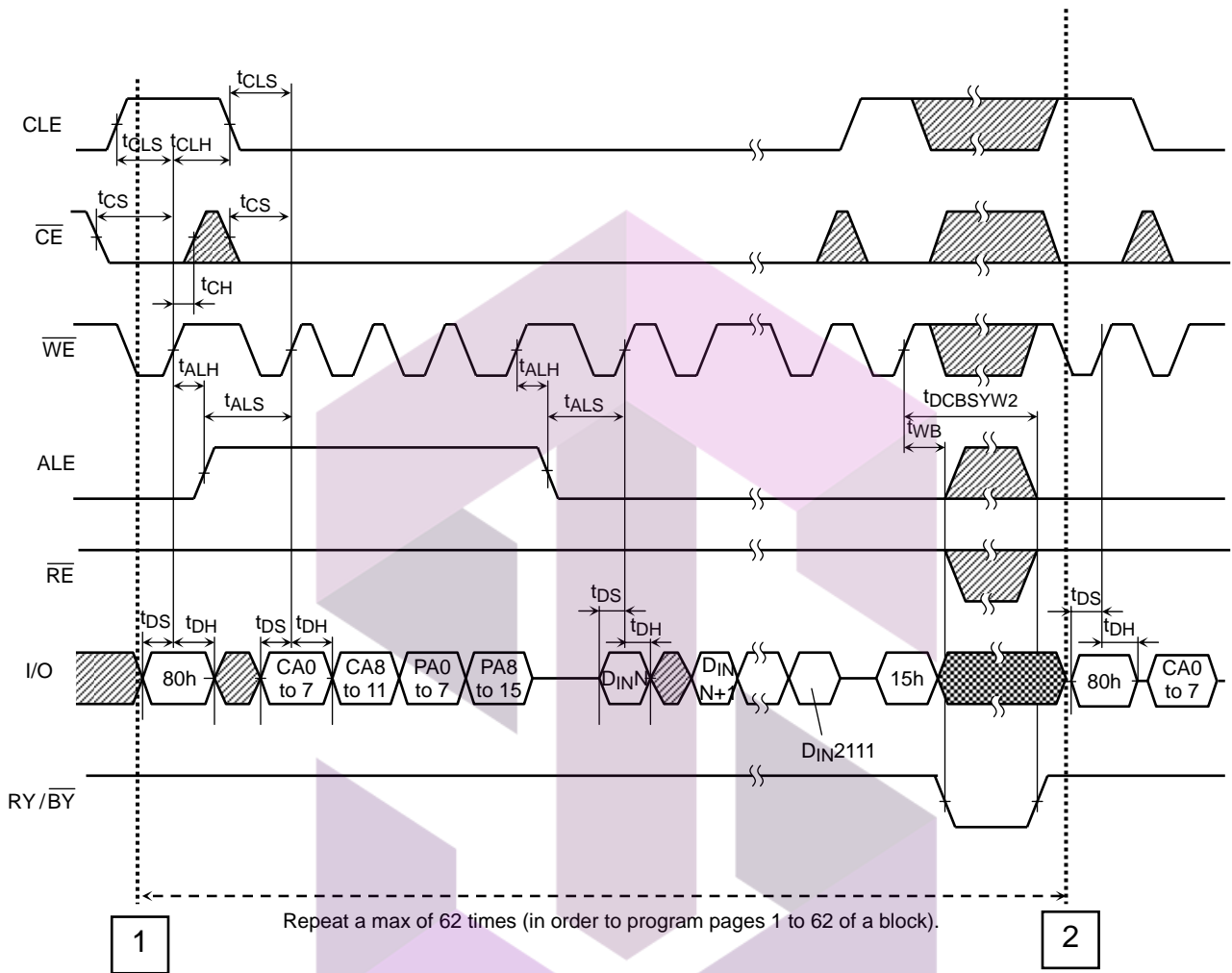

Continued from 1 of last page

- : Do not input data while data is being output.
- :  $V_{IH}$  or  $V_{IL}$

SKYTECH

تهیه و توزیع قطعات الکترونیک

Auto-Program Operation with Data Cache Timing Diagram (3/3)

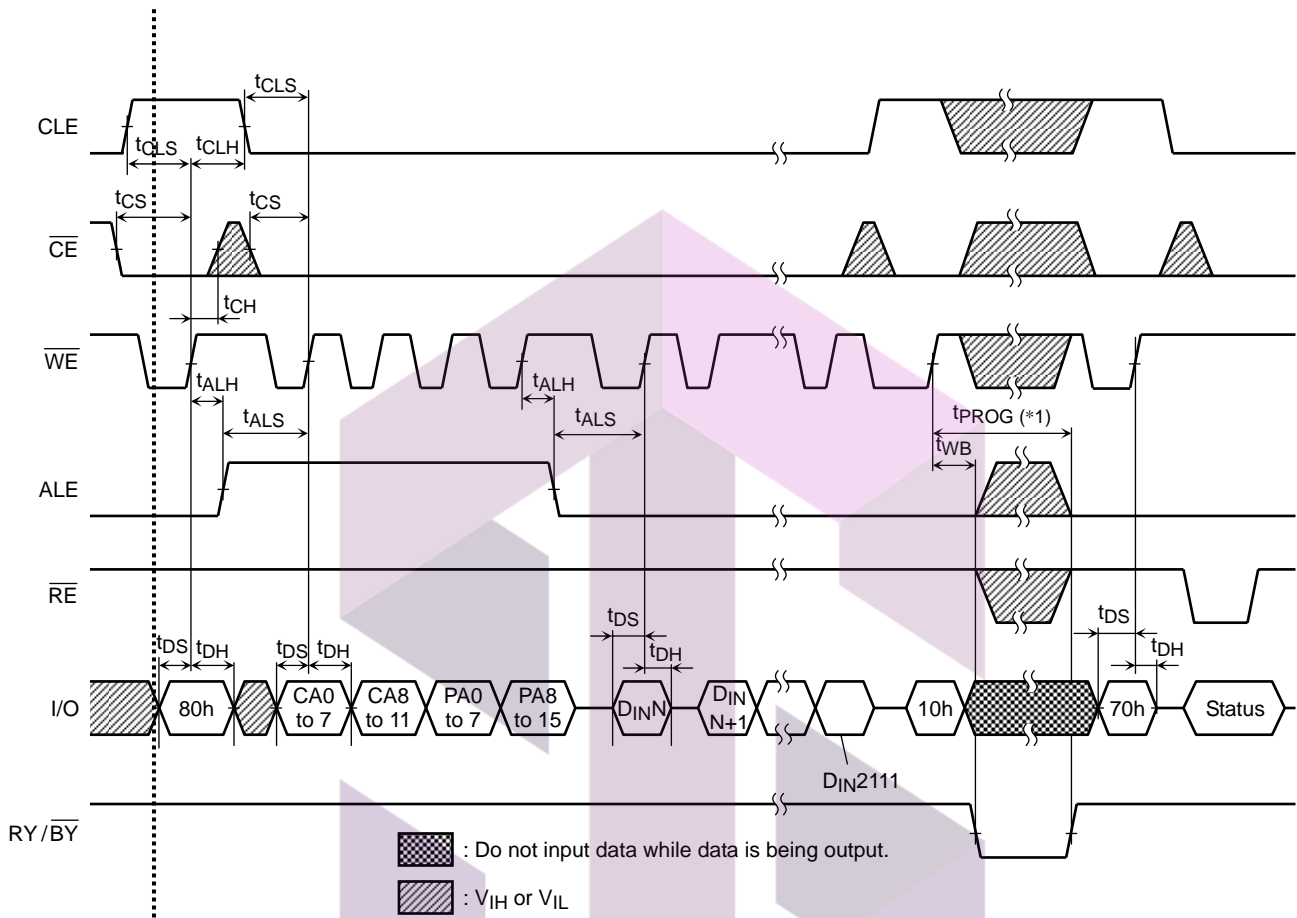

2

Continued from 2 of last page

(\*1)  $t_{PROG}$ : Since the last page programming by 10h command is initiated after the previous cache program, the  $t_{PROG}$  during cache programming is given by the following equation.

$$t_{PROG} = t_{PROG} \text{ of the last page} + t_{PROG} \text{ of the previous page} - A$$

$$A = (\text{command input cycle} + \text{address input cycle} + \text{data input cycle time of the last page})$$

If "A" exceeds the  $t_{PROG}$  of previous page,  $t_{PROG}$  of the last page is  $t_{PROG} \text{ max}$ .

(Note) Make sure to terminate the operation with 80h-10h- command sequence.  
 If the operation is terminated by 80h-15h command sequence, monitor I/O 6 (Ready / Busy) by issuing Status Read command (70h) and make sure the previous page program operation is completed. If the page program operation is completed issue FFh reset before next operation.

تهیه و توزیع قطعات الکترونیک

Multi-Page Program Operation with Data Cache Timing Diagram (1/4)

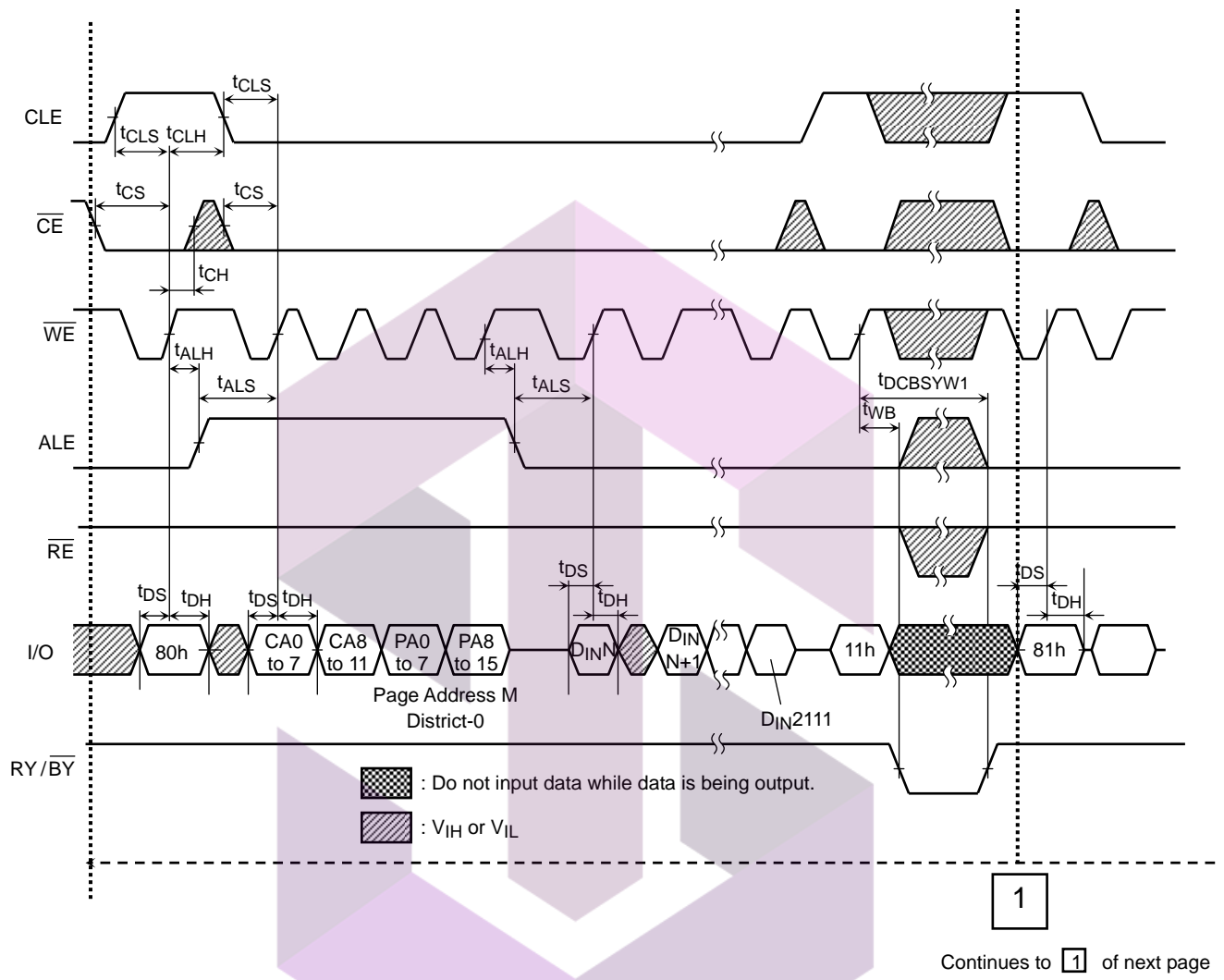

SKYTECH

تهیه و توزیع قطعات الکترونیک

Multi-Page Program Operation with Data Cache Timing Diagram (2/4)

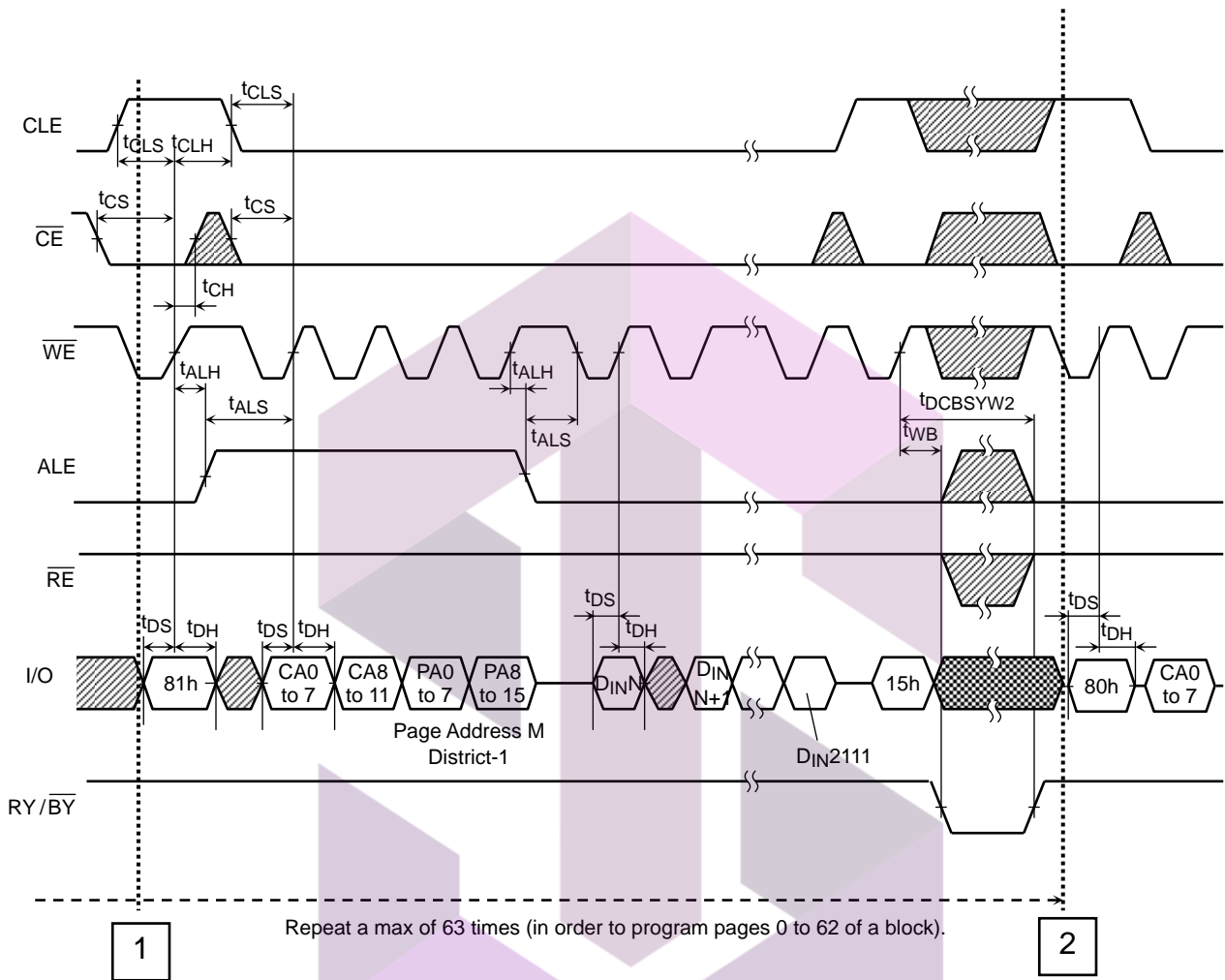

Continued from 1 of last page

- : Do not input data while data is being output.
- : V<sub>IH</sub> or V<sub>IL</sub>

SKYTECH

تهیه و توزیع قطعات الکترونیک

Multi-Page Program Operation with Data Cache Timing Diagram (3/4)

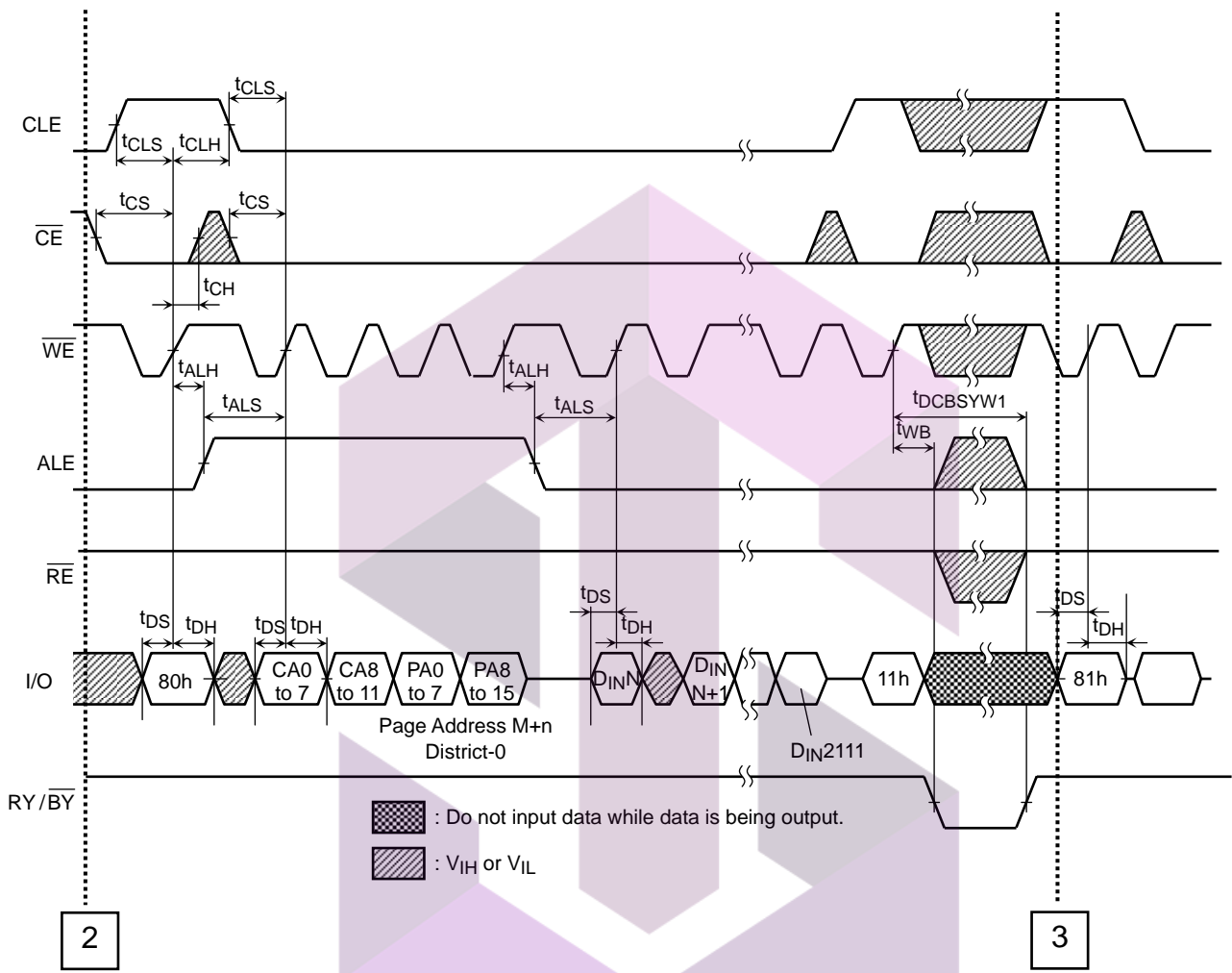

Continues to 3 of next page



تهیه و توزیع قطعات الکترونیک

Multi-Page Program Operation with Data Cache Timing Diagram (4/4)

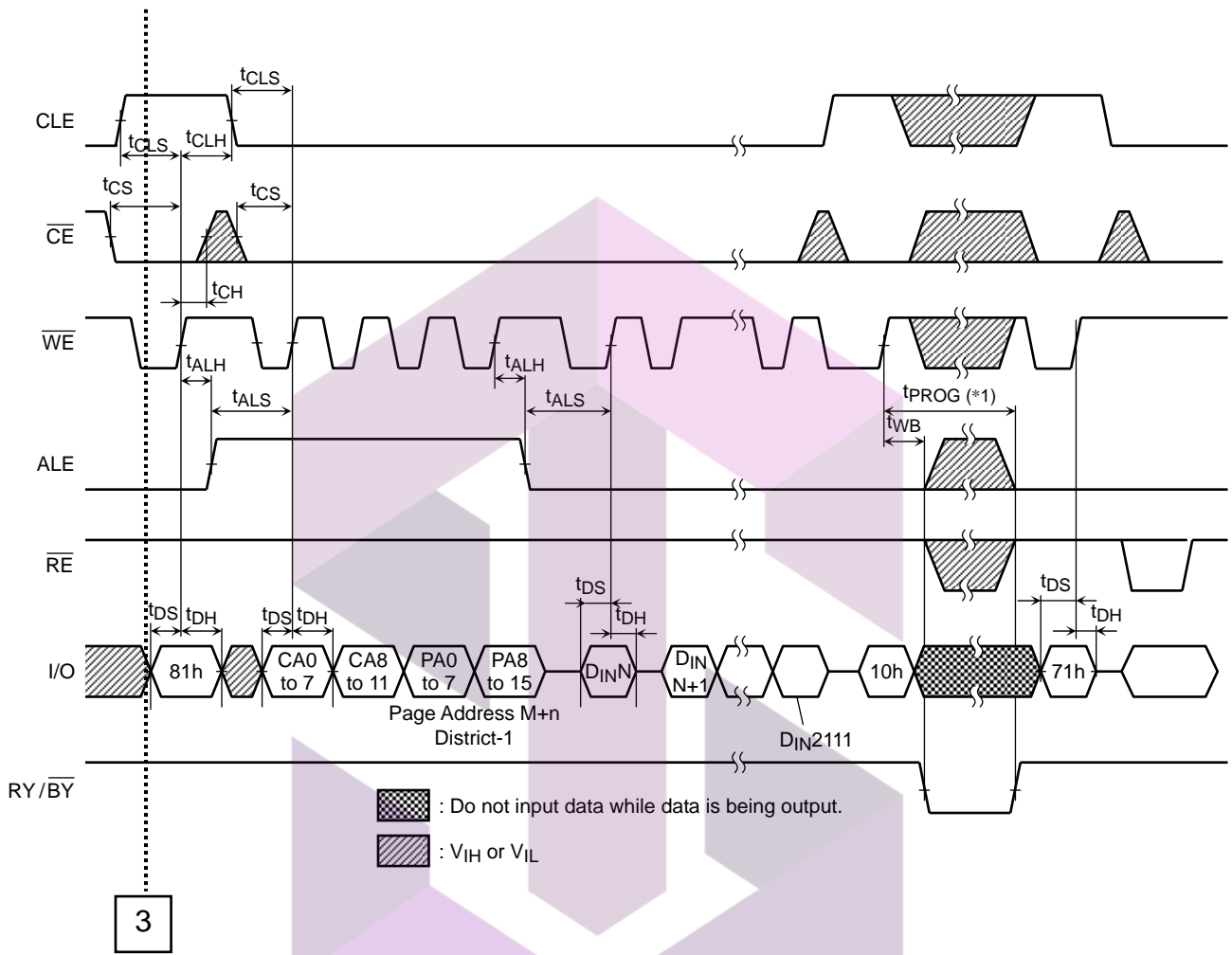

Continued from **3** of last page

(\*1)  $t_{PROG}$ : Since the last page programming by 10h command is initiated after the previous cache program, the  $t_{PROG}$  during cache programming is given by the following equation.

$$t_{PROG} = t_{PROG} \text{ of the last page} + t_{PROG} \text{ of the previous page} - A$$

$$A = (\text{command input cycle} + \text{address input cycle} + \text{data input cycle time of the last page})$$

If "A" exceeds the  $t_{PROG}$  of previous page,  $t_{PROG}$  of the last page is  $t_{PROG} \text{ max.}$



(Note) Make sure to terminate the operation with 80h-10h- command sequence.  
 If the operation is terminated by 81h-15h command sequence, monitor I/O 6 (Ready / Busy) by issuing Status Read command (70h) and make sure the previous page program operation is completed. If the page program operation is completed issue FFh reset before next operation.

Auto Block Erase Timing Diagram

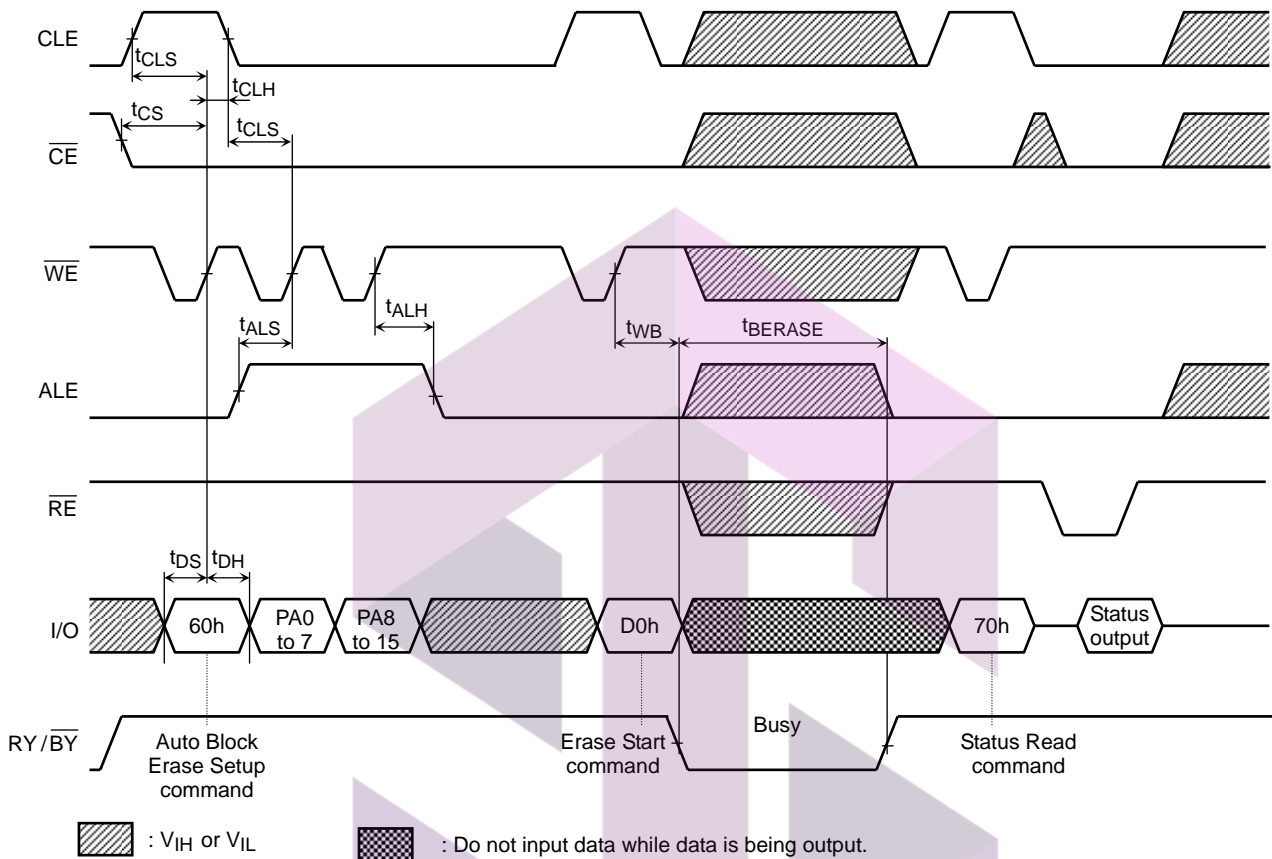

SKYTECH

تهیه و توزیع قطعات الکترونیک



Multi Block Erase Timing Diagram

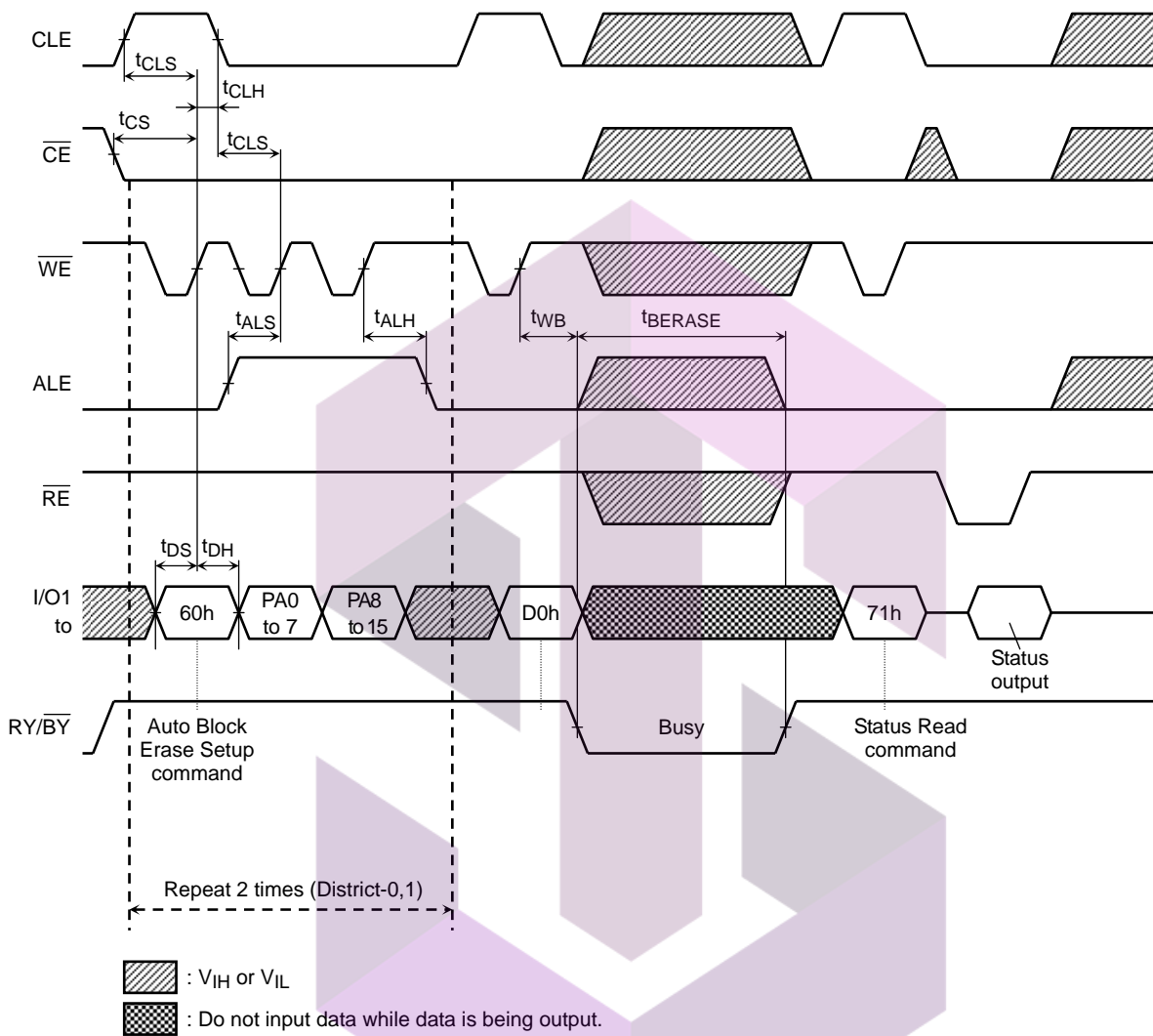

SKYTECH

تهیه و توزیع قطعات الکترونیک

ID Read Operation Timing Diagram

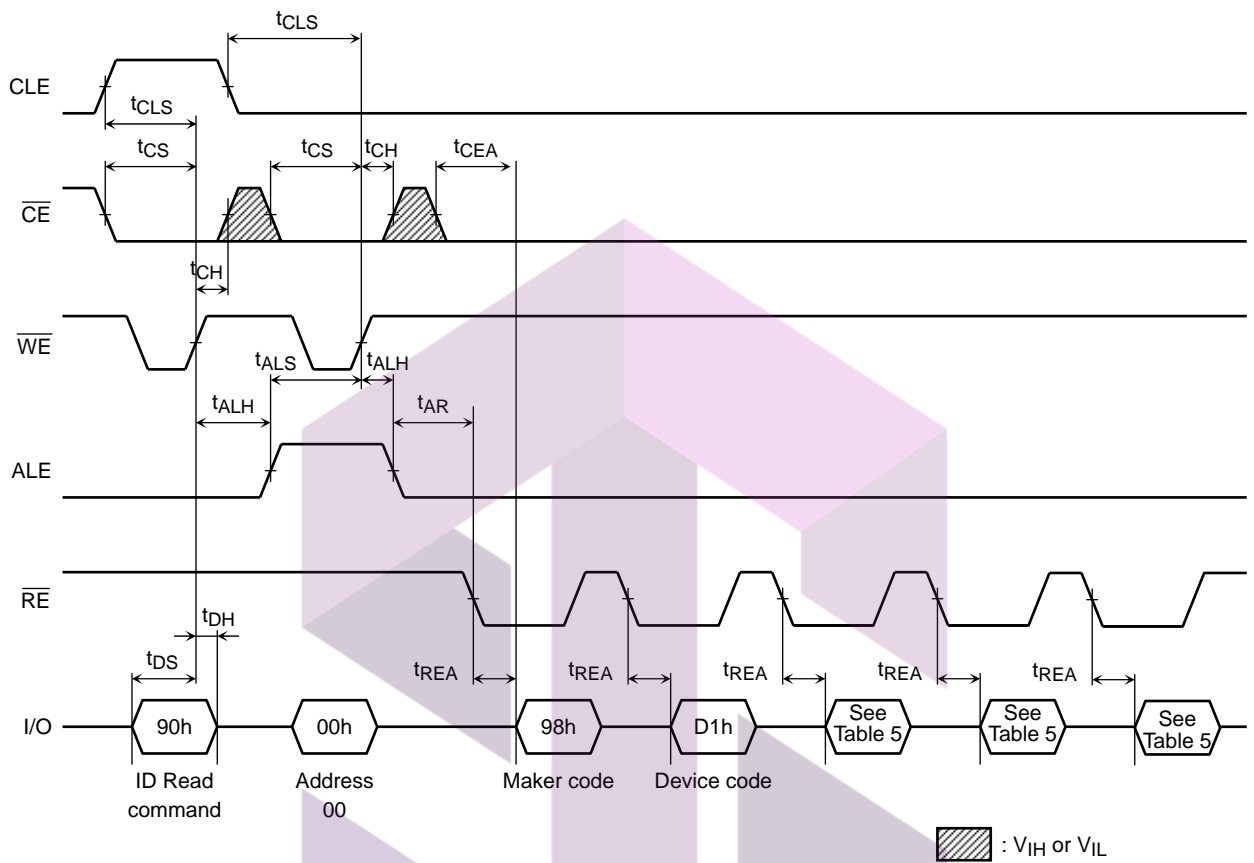

SKYTECH

تهیه و توزیع قطعات الکترونیک

## PIN FUNCTIONS

The device is a serial access memory which utilizes time-sharing input of address information.

### Command Latch Enable: CLE

The CLE input signal is used to control loading of the operation mode command into the internal command register. The command is latched into the command register from the I/O port on the rising edge of the  $\overline{WE}$  signal while CLE is High.

### Address Latch Enable: ALE

The ALE signal is used to control loading address information into the internal address register. Address information is latched into the address register from the I/O port on the rising edge of  $\overline{WE}$  while ALE is High.

### Chip Enable: $\overline{CE}$

The device goes into a low-power Standby mode when  $\overline{CE}$  goes High during the device is in Ready state. The  $\overline{CE}$  signal is ignored when device is in Busy state ( $RY/\overline{BY} = L$ ), such as during a Program or Erase or Read operation, and will not enter Standby mode even if the  $\overline{CE}$  input goes High.

### Write Enable: $\overline{WE}$

The  $\overline{WE}$  signal is used to control the acquisition of data from the I/O port.

### Read Enable: $\overline{RE}$

The  $\overline{RE}$  signal controls serial data output. Data is available  $t_{REA}$  after the falling edge of  $\overline{RE}$ . The internal column address counter is also incremented (Address = Address + 1) on this falling edge.

### I/O Port: I/O1 to 8

The I/O1 to 8 pins are used as a port for transferring address, command and input/output data to and from the device.

### Write Protect: $\overline{WP}$

The  $\overline{WP}$  signal is used to protect the device from accidental programming or erasing. The internal voltage regulator is reset when  $\overline{WP}$  is Low. This signal is usually used for protecting the data during the power-on/off sequence when input signals are invalid.

### Ready/Busy: $RY/\overline{BY}$

The  $RY/\overline{BY}$  output signal is used to indicate the operating condition of the device. The  $RY/\overline{BY}$  signal is in Busy state ( $RY/\overline{BY} = L$ ) during the Program, Erase and Read operations and will return to Ready state ( $RY/\overline{BY} = H$ ) after completion of the operation. The output buffer for this signal is an open drain and has to be pulled-up to  $V_{ccq}$  with an appropriate resistor.

If  $RY/\overline{BY}$  signal is not pulled-up to  $V_{ccq}$  ("Open" state), device operation can not guarantee.

SKYTECH

تهیه و توزیع قطعات الکترونیک

Schematic Cell Layout and Address Assignment

The Program operation works on page units while the Erase operation works on block units.

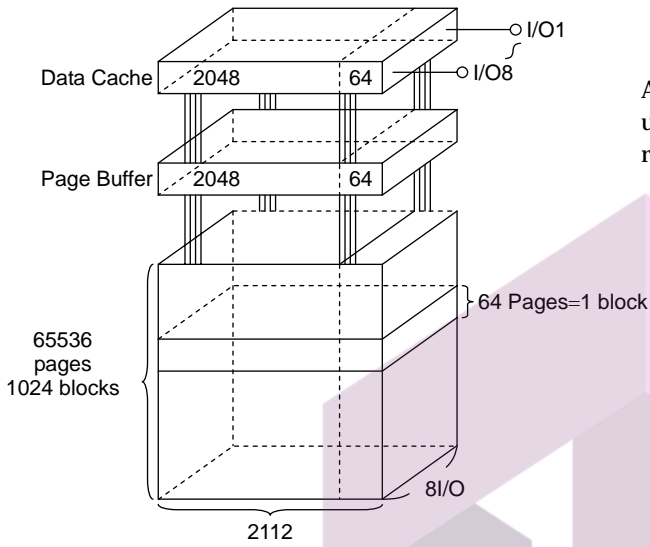

A page consists of 2112 bytes in which 2048 bytes are used for main memory storage and 64 bytes are for redundancy or for other uses.

1 page = 2112 bytes

1 block = 2112 bytes × 64 pages = (128K + 4K) bytes

Capacity = 2112 bytes × 64pages × 1024 blocks

An address is read in via the I/O port over four consecutive clock cycles, as shown in Table 1.

Table 1. Addressing

	I/O8	I/O7	I/O6	I/O5	I/O4	I/O3	I/O2	I/O1
First cycle	CA7	CA6	CA5	CA4	CA3	CA2	CA1	CA0
Second cycle	L	L	L	L	CA11	CA10	CA9	CA8
Third cycle	PA7	PA6	PA5	PA4	PA3	PA2	PA1	PA0
Fourth cycle	PA15	PA14	PA13	PA12	PA11	PA10	PA9	PA8

CA0 to CA11: Column address  
PA0 to PA15: Page address

PA6 to PA15: Block address  
PA0 to PA5: NAND address in block



تهیه و توزیع قطعات الکترونیک

Operation Mode: Logic and Command Tables

The operation modes such as Program, Erase, Read and Reset are controlled by command operations shown in Table 3. Address input, command input and data input/output are controlled by the CLE, ALE,  $\overline{CE}$ ,  $\overline{WE}$ ,  $\overline{RE}$  and  $\overline{WP}$  signals, as shown in Table 2.

Table 2. Logic Table

	CLE	ALE	$\overline{CE}$	$\overline{WE}$	$\overline{RE}$	$\overline{WP}$ *1
Command Input	H	L	L		H	*
Data Input	L	L	L		H	H
Address input	L	H	L		H	*
Serial Data Output	L	L	L	H		*
During Program (Busy)	*	*	*	*	*	H
During Erase (Busy)	*	*	*	*	*	H
During Read (Busy)	*	*	H	*	*	*
	*	*	L	H (*2)	H (*2)	*
Program, Erase Inhibit	*	*	*	*	*	L
Standby	*	*	H	*	*	0 V/V <sub>CC</sub>

H: V<sub>IH</sub>, L: V<sub>IL</sub>, \*: V<sub>IH</sub> or V<sub>IL</sub>

\*1: Refer to Application Note (10) toward the end of this document regarding the  $\overline{WP}$  signal when Program or Erase Inhibit

\*2: If  $\overline{CE}$  is low during read busy,  $\overline{WE}$  and  $\overline{RE}$  must be held High to avoid unintended command/address input to the device or read to device. Reset or Status Read command can be input during Read Busy.

**SKYTECH**

تهیه و توزیع قطعات الکترونیک

Table 3. Command table (HEX)

	First Cycle	Second Cycle	Acceptable while Busy
Serial Data Input	80	—	
Read	00	30	
Column Address Change in Serial Data Output	05	E0	
Read with Data Cache	31	—	
Read Start for Last Page in Read Cycle with Data Cache	3F	—	
Auto Page Program	80	10	
Column Address Change in Serial Data Input	85	—	
Auto Program with Data Cache	80	15	
Multi Page Program	80	11	
	81	15	
	81	10	
Read for Page Copy (2) with Data Out	00	3A	
Auto Program with Data Cache during Page Copy (2)	8C	15	
Auto Program for last page during Page Copy (2)	8C	10	
Auto Block Erase	60	D0	
ID Read	90	—	
Status Read	70	—	○
Status Read for Multi-Page Program or Multi Block Erase	71	—	○
Reset	FF	—	○

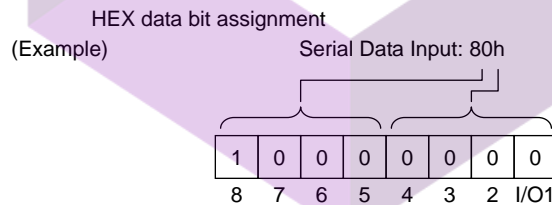

Table 4. Read mode operation states

	CLE	ALE	$\overline{CE}$	$\overline{WE}$	$\overline{RE}$	I/O1 to I/O8	Power
Output select	L	L	L	H	L	Data output	Active
Output Deselect	L	L	L	H	H	High impedance	Active

H:  $V_{IH}$ , L:  $V_{IL}$

تهیه و توزیع قطعات الکترونیک

**DEVICE OPERATION**

Read Mode

Read mode is set when the "00h" and "30h" commands are issued to the Command register. Between the two commands, a start address for the Read mode needs to be issued. Refer to the figures below for the sequence and the block diagram (Refer to the detailed timing chart.).

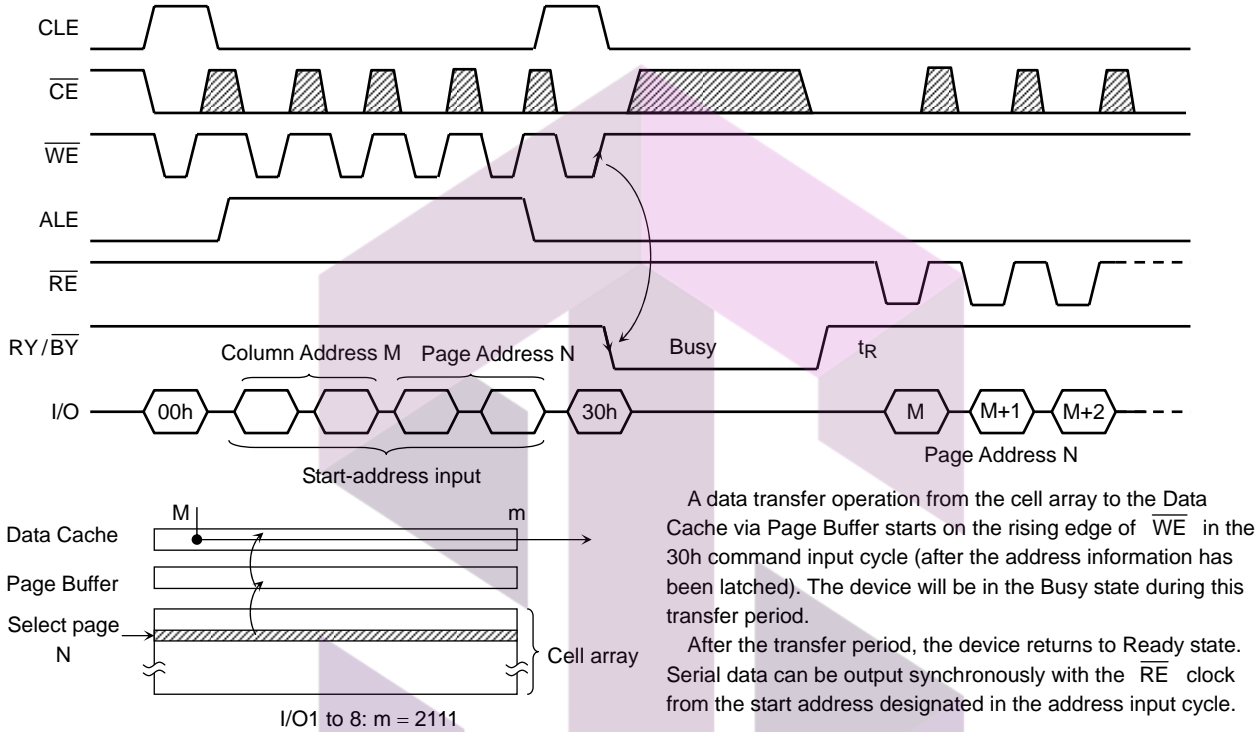

Random Column Address Change in Read Cycle

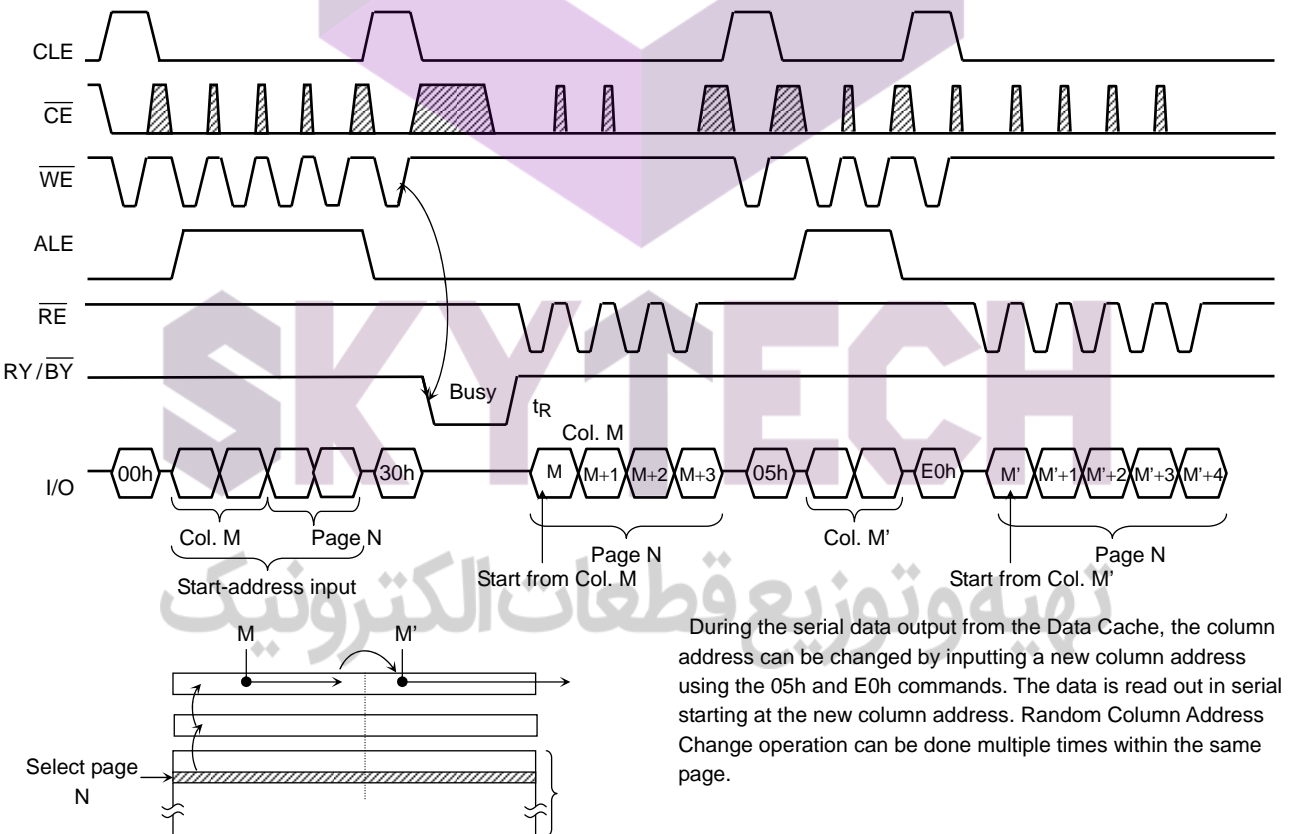

## Read Operation with Read Cache

The device has a Read operation with Data Cache that enables the high speed read operation shown below. When the block address changes, this sequence has to be started from the beginning.

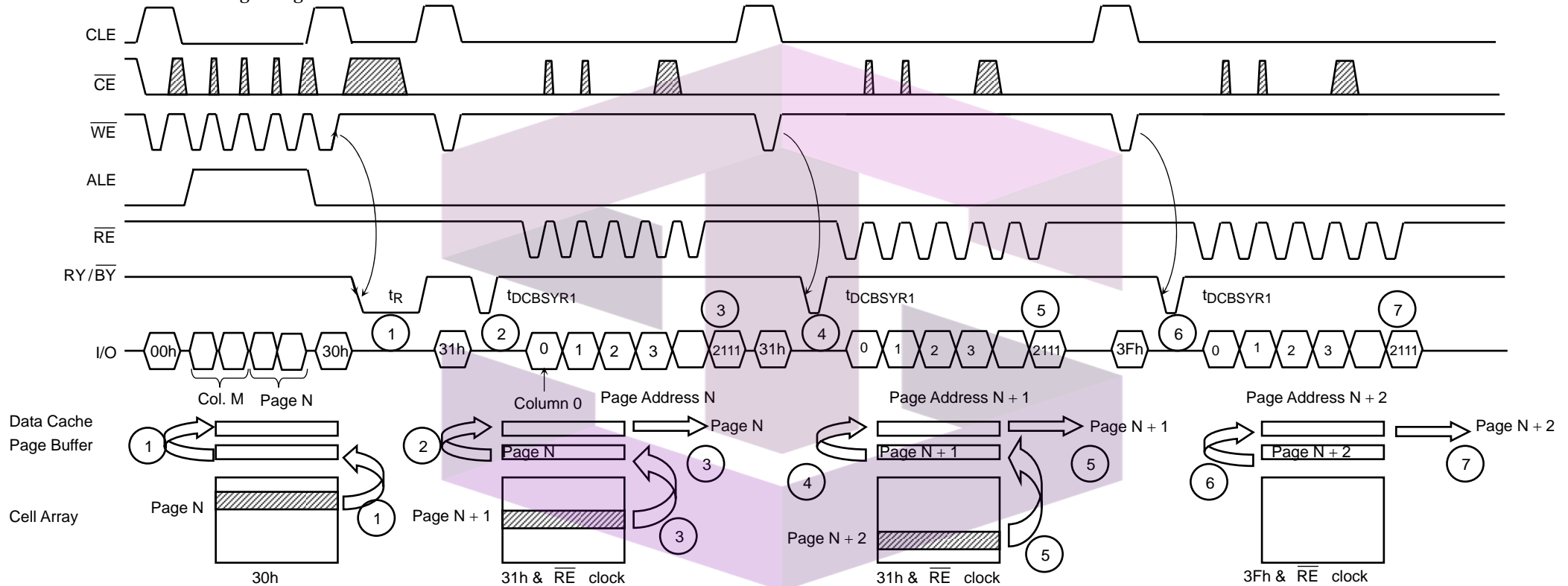

If the 31h command is issued to the device, the data content of the next page is transferred to the Page Buffer during serial data out from the Data Cache, and therefore the  $t_R$  (Data transfer from memory cell to data register) will be reduced.

- 1 Normal read. Data is transferred from Page N to Data Cache through Page Buffer. During this time period, the device outputs Busy state for  $t_R$  max.
- 2 After the Ready/Busy returns to Ready, 31h command is issued and data is transferred to Data Cache from Page Buffer again. This data transfer takes  $t_{DCBSYR1}$  max and the completion of this time period can be detected by Ready/Busy signal.
- 3 Data of Page N + 1 is transferred to Page Buffer from cell while the data of Page N in Data cache can be read out by /RE clock simultaneously.
- 4 The 31h command makes data of Page N + 1 transfer to Data Cache from Page Buffer after the completion of the transfer from cell to Page Buffer. The device outputs Busy state for  $t_{DCBSYR1}$  max.. This Busy period depends on the combination of the internal data transfer time from cell to Page buffer and the serial data out time.
- 5 Data of Page N + 2 is transferred to Page Buffer from cell while the data of Page N + 1 in Data cache can be read out by /RE clock simultaneously
- 6 The 3Fh command makes the data of Page N + 2 transfer to the Data Cache from the Page Buffer after the completion of the transfer from cell to Page Buffer. The device outputs Busy state for  $t_{DCBSYR1}$  max.. This Busy period depends on the combination of the internal data transfer time from cell to Page buffer and the serial data out time.
- 7 Data of Page N + 2 in Data Cache can be read out, but since the 3Fh command does not transfer the data from the memory cell to Page Buffer, the device can accept new command input immediately after the completion of serial data out.



Multi Page Read Operation

The device has a Multi Page Read operation and Multi Page Read with Data Cache operation.

(1) Multi Page Read without Data Cache

The sequence of command and address input is shown below.

Same page address (PA0 to PA5) within each district has to be selected.

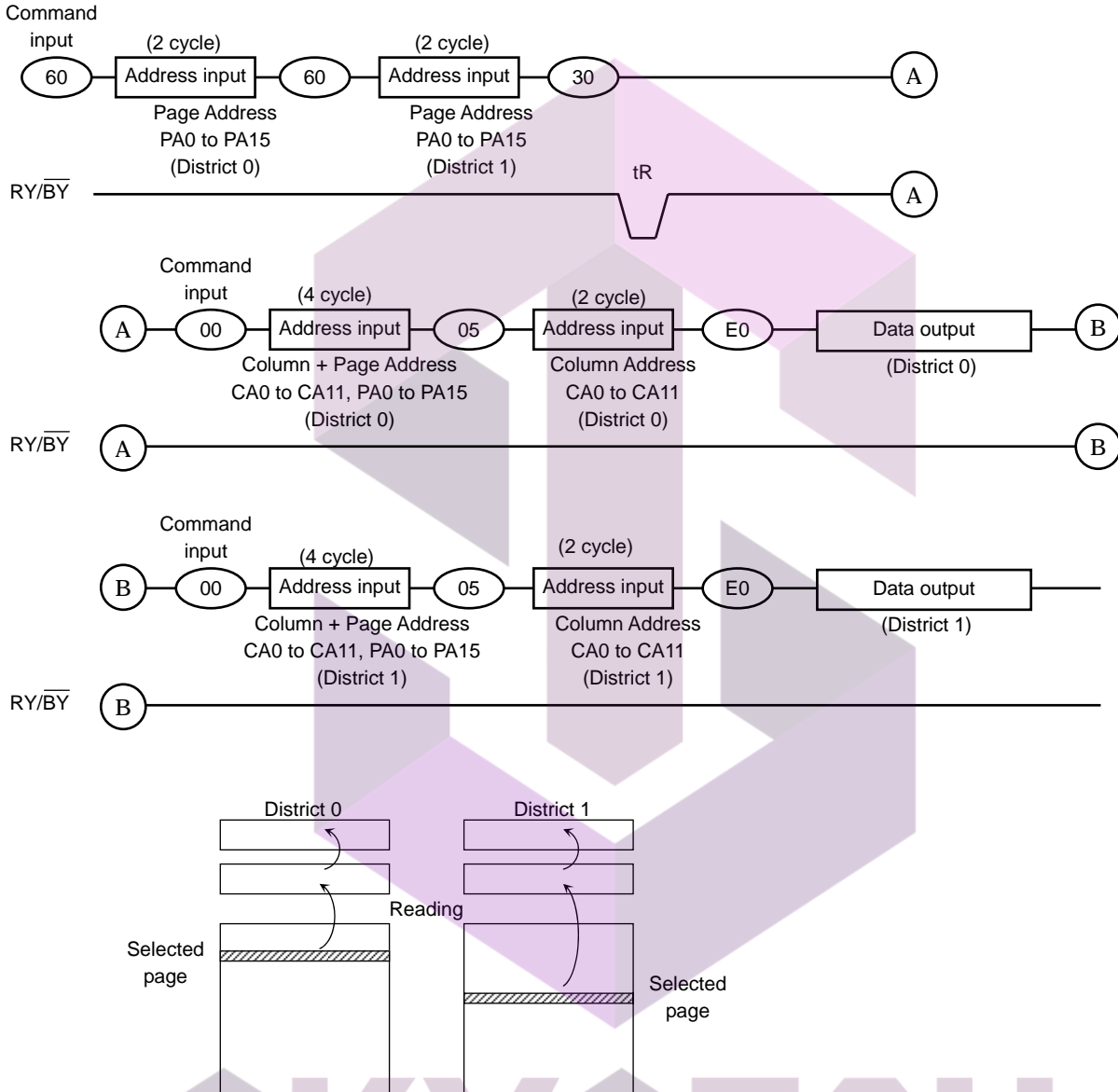

The data transfer operation from the cell array to the Data Cache via Page Buffer starts on the rising edge of  $\overline{WE}$  in the 30h command input cycle (after the 2 Districts address information has been latched). The device will be in the Busy state during this transfer period.

After the transfer period, the device returns to Ready state. Serial data can be output synchronously with the  $\overline{RE}$  clock from the start address designated in the address input cycle.

تهیه و توزیع قطعات الکترونیک

(2) Multi Page Read with Data Cache

When the block address changes (increments) this sequenced has to be started from the beginning.  
 The sequence of command and address input is shown below.  
 Same page address (PA0 to PA5) within each district has to be selected.

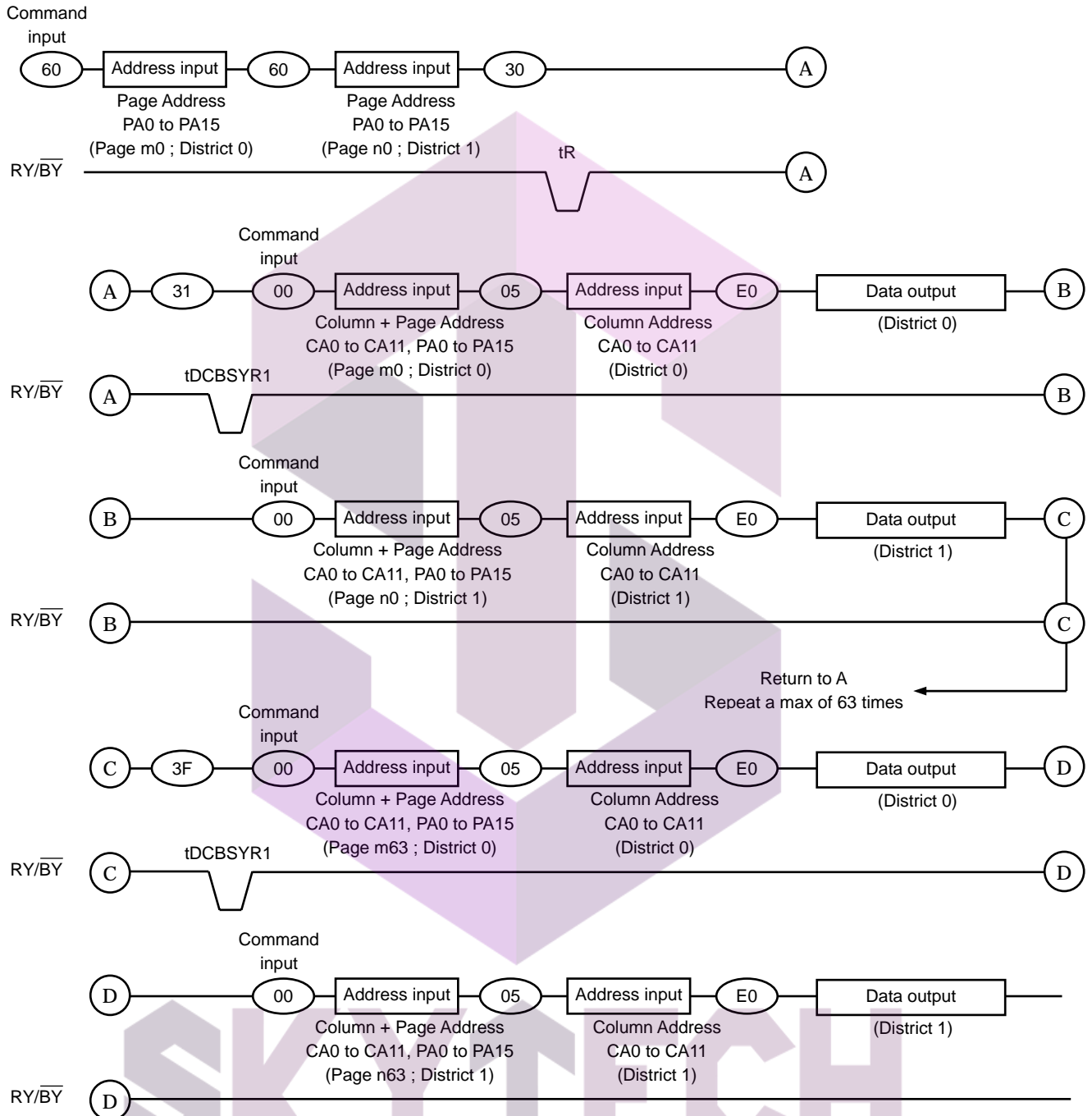

تهیه و توزیع قطعات الکترونیک

## (3) Notes

## (a) Internal addressing in relation with the Districts

To use Multi Page Read operation, the internal addressing should be considered in relation with the District.

- The device consists from 2 Districts.
- Each District consists from 512 erase blocks.
- The allocation rule is follows.

District 0: Block 0, Block 2, Block 4, Block 6,..., Block 1022

District 1: Block 1, Block 3, Block 5, Block 7,..., Block 1023

## (b) Address input restriction for the Multi Page Read operation

There are following restrictions in using Multi Page Read;

## (Restriction)

Maximum one block should be selected from each District.

Same page address (PA0 to PA5) within two districts has to be selected.

For example;

(60) [District 0, Page Address 0x0000] (60) [District 1, Page Address 0x0040] (30)

(60) [District 0, Page Address 0x0001] (60) [District 1, Page Address 0x0041] (30)

## (Acceptance)

There is no order limitation of the District for the address input.

For example, following operation is accepted;

(60) [District 0] (60) [District 1] (30)

(60) [District 1] (60) [District 0] (30)

It requires no mutual address relation between the selected blocks from each District.

(c)  $\overline{WP}$  signal

Make sure  $\overline{WP}$  is held to High level when Multi Page Read operation is performed

SKYTECH

تهیه و توزیع قطعات الکترونیک

Auto Page Program Operation

The device carries out an Automatic Page Program operation when it receives a "10h" Program command after the address and data have been input. The sequence of command, address and data input is shown below. (Refer to the detailed timing chart.)

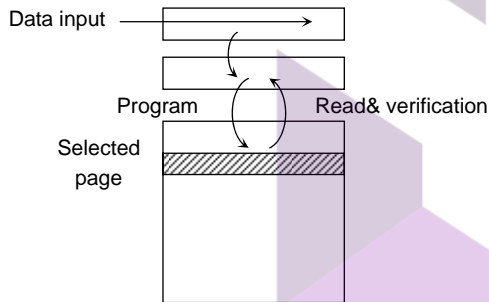
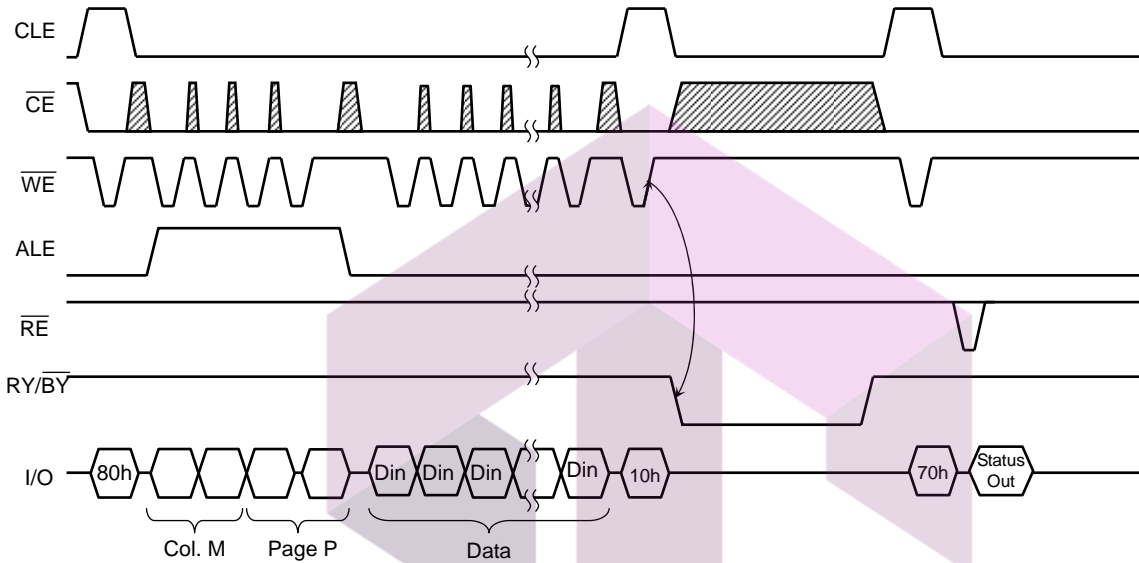

The data is transferred (programmed) from the Data Cache via the Page Buffer to the selected page on the rising edge of WE following input of the "10h" command. After programming, the programmed data is transferred back to the Page Buffer to be automatically verified by the device. If the programming does not succeed, the Program/Verify operation is repeated by the device until success is achieved or until the maximum loop number set in the device is reached.

Random Column Address Change in Auto Page Program Operation

The column address can be changed by the 85h command during the data input sequence of the Auto Page Program operation.

Two address input cycles after the 85h command are recognized as a new column address for the data input. After the new data is input to the new column address, the 10h command initiates the actual data program into the selected page automatically. The Random Column Address Change operation can be repeated multiple times within the same page.

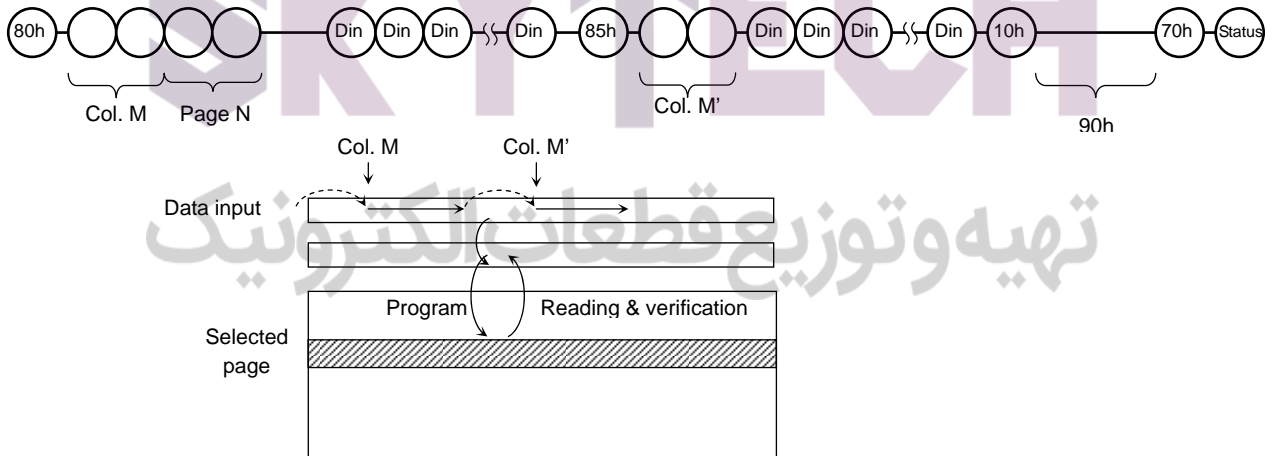

**Multi Page Program**

The device has a Multi Page Program, which enables even higher speed program operation compared to Auto Page Program. The sequence of command, address and data input is shown bellow. (Refer to the detailed timing chart.)

Although two planes are programmed simultaneously, pass/fail is not available for each page when the program operation completes. Status bit of I/O 0 is set to "1" when any of the pages fails. Limitation in addressing with Multi Page Program is shown below.

**Multi Page Program**

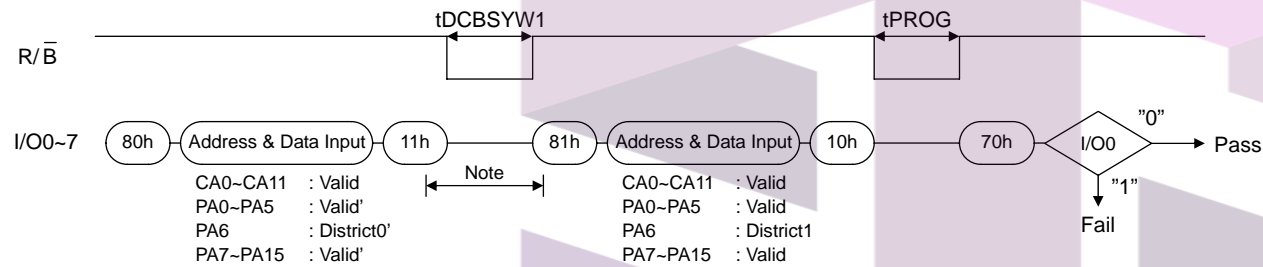

NOTE: Any command between 11h and 81h is prohibited except 70h and FFh.

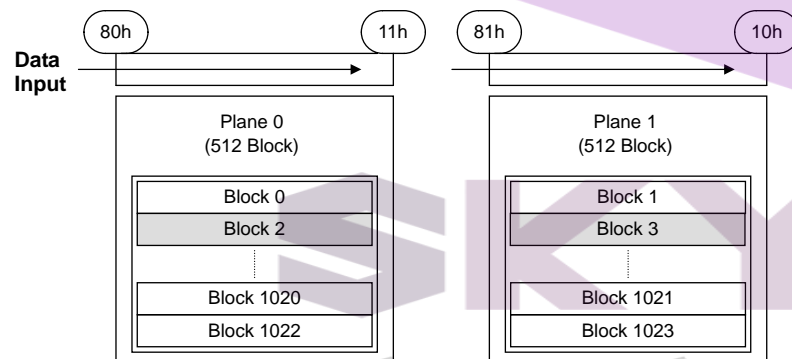

Auto Page Program Operation with Data Cache

The device has an Auto Page Program with Data Cache operation enabling the high speed program operation shown below. When the block address changes this sequenced has to be started from the beginning.

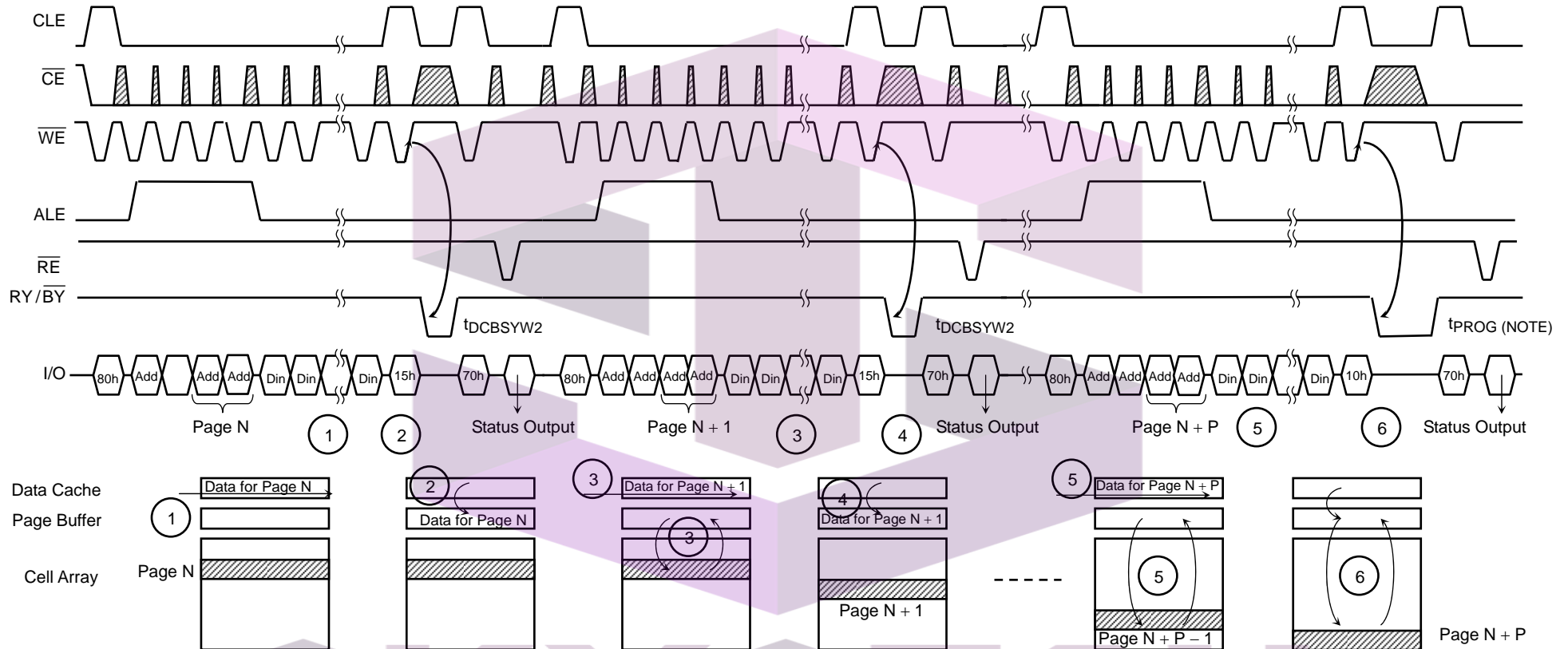

Issuing the 15h command to the device after serial data input initiates the program operation with Data Cache

- 1 Data for Page N is input to Data Cache.
- 2 Data is transferred to the Page Buffer by the 15h command. During the transfer the Ready/Busy outputs Busy State (t<sub>DCBSYW2</sub>).
- 3 Data is programmed to the selected page while the data for page N + 1 is input to the Data Cache.
- 4 By the 15h command, the data in the Data Cache is transferred to the Page Buffer after the programming of page N is completed. The device output busy state from the 15h command until the Data Cache becomes empty. The duration of this period depends on timing between the internal programming of page N and serial data input for Page N + 1 (t<sub>DCBSYW2</sub>).
- 5 Data for Page N + P is input to the Data Cache while the data of the Page N + P - 1 is being programmed.
- 6 The programming with Data Cache is terminated by the 10h command. When the device becomes Ready, it shows that the internal programming of the Page N + P is completed.

NOTE: Since the last page programming by the 10h command is initiated after the previous cache program, the t<sub>PROG</sub> during cache programming is given by the following;

$$t_{PROG} = t_{PROG} \text{ for the last page} + t_{PROG} \text{ of the previous page} - (\text{command input cycle} + \text{address input cycle} + \text{data input cycle time of the previous page})$$

Pass/fail status for each page programmed by the Auto Page Programming with Data Cache operation can be detected by the Status Read operation.

- I/O1 : Pass/fail of the current page program operation.
- I/O2 : Pass/fail of the previous page program operation.

The Pass/Fail status on I/O1 and I/O2 are valid under the following conditions.

- Status on I/O1: Page Buffer Ready/Busy is Ready State.  
The Page Buffer Ready/Busy is output on I/O6 by Status Read operation or RY/ $\overline{\text{BY}}$  pin after the 10h command
- Status on I/O2: Data Cache Read/Busy is Ready State.  
The Data Cache Ready/Busy is output on I/O7 by Status Read operation or RY/ $\overline{\text{BY}}$  pin after the 15h command.

Example)

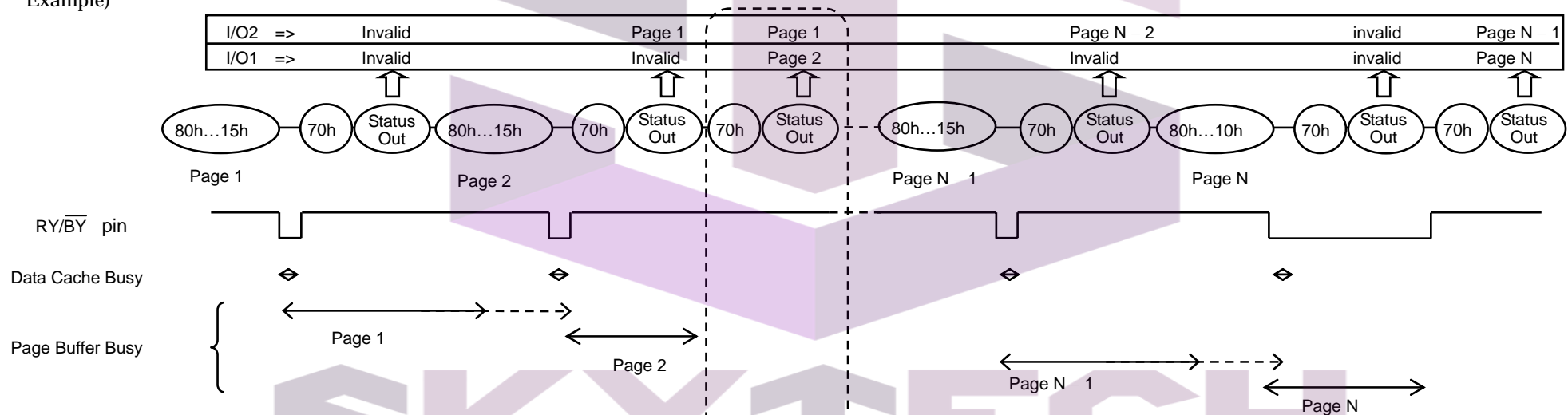

SKYYTECH  
 تمهده وتوزيع قطعات الكترونيك

If the Page Buffer Busy returns to Ready before the next 80h command input, and if Status Read is done during this Ready period, the Status Read provides pass/fail for Page 2 on I/O1 and pass/fail result for Page1 on I/O2

Multi Page Program with Data Cache

The device has a Multi Page Program with Data Cache operation, which enables even higher speed program operation compared to Auto Page Program with Data Cache as shown below. When the block address changes (increments) this sequenced has to be started from the beginning.

The sequence of command, address and data input is shown below. (Refer to the detailed timing chart.)

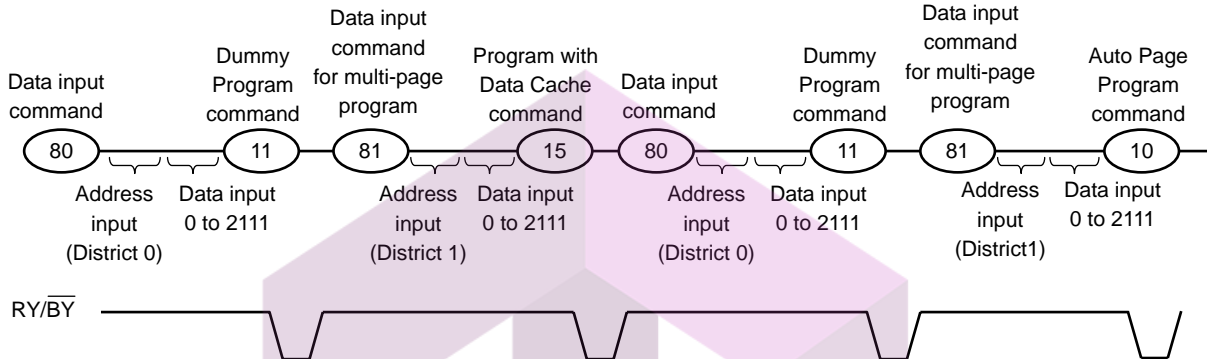

After “15h” or “10h” Program command is input to device, physical programming starts as follows. For details of Auto Program with Data Cache, refer to “Auto Page Program with Data Cache”.

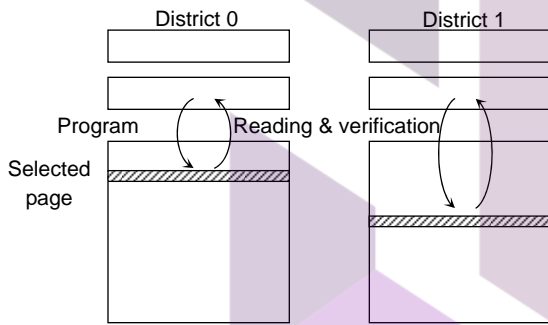

The data is transferred (programmed) from the page buffer to the selected page on the rising edge of /WE following input of the “15h” or “10h” command. After programming, the programmed data is transferred back to the register to be automatically verified by the device. If the programming does not succeed, the Program/Verify operation is repeated by the device until success is achieved or until the maximum loop number set in the device is reached.



تهیه و توزیع قطعات الکترونیک



Starting the above operation from 1st page of the selected erase blocks, and then repeating the operation total 64 times with incrementing the page address in the blocks, and then input the last page data of the blocks, "10h" command executes final programming. Make sure to terminate with 81h-10h- command sequence.

In this full sequence, the command sequence is following.

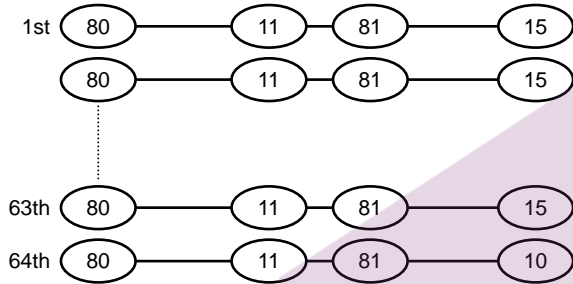

After the "15h" or "10h" command, the results of the above operation is shown through the "71h" Status Read command.

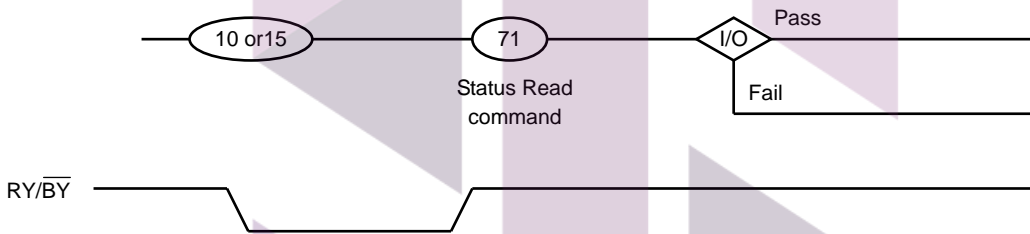

The 71h command Status description is as below.

	STATUS	OUTPUT	
I/O1	Chip Status1 : Pass/Fail	Pass: 0	Fail: 1
I/O2	District 0 Chip Status1 : Pass/Fail	Pass: 0	Fail: 1
I/O3	District 1 Chip Status1 : Pass/Fail	Pass: 0	Fail: 1
I/O4	District 0 Chip Status2 : Pass/Fail	Pass: 0	Fail: 1
I/O5	District 1 Chip Status2 : Pass/Fail	Pass: 0	Fail: 1
I/O6	Ready/Busy	Ready: 1	Busy: 0
I/O7	Data Cache Ready/Busy	Ready: 1	Busy: 0
I/O8	Write Protect	Protect: 0	Not Protect: 1

I/O1 describes Pass/Fail condition of district 0 and 1(OR data of I/O2 and I/O3). If one of the districts fails during multi page program operation, it shows "Fail".

I/O2 to 5 shows the Pass/Fail condition of each district. For details on "Chip Status1" and "Chip Status2", refer to section "Status Read".

تهیه و توزیع قطعات الکترونیک

### Internal addressing in relation with the Districts

To use Multi Page Program operation, the internal addressing should be considered in relation with the District.

- The device consists from 2 Districts.
- Each District consists from 512 erase blocks.
- The allocation rule is follows.
  - District 0: Block 0, Block 2, Block 4, Block 6,..., Block 1022
  - District 1: Block 1, Block 3, Block 5, Block 7,..., Block 1023

### Address input restriction for the Multi Page Program with Data Cache operation

There are following restrictions in using Multi Page Program with Data Cache;

(Restriction)

Maximum one block should be selected from each District.

Same page address (PA0 to PA5) within two districts has to be selected.

For example;

(80) [District 0, Page Address 0x0000] (11) (81) [District 1, Page Address 0x0040] (15 or 10)

(80) [District 0, Page Address 0x0001] (11) (81) [District 1, Page Address 0x0041] (15 or 10)

(Acceptance)

There is no order limitation of the District for the address input.

For example, following operation is accepted;

(80) [District 0] (11) (81) [District 1] (15 or 10)

(80) [District 1] (11) (81) [District 0] (15 or 10)

It requires no mutual address relation between the selected blocks from each District.

### Operating restriction during the Multi Page Program with Data Cache operation

(Restriction)

The operation has to be terminated with "10h" command.

Once the operation is started, no commands other than the commands shown in the timing diagram is allowed to be input except for Status Read command and reset command.

The logo for SKYTECH, featuring the word "SKYTECH" in a bold, stylized, sans-serif font. The letters are white with a purple outline. The 'S' and 'K' are connected, and the 'Y' has a unique shape with a vertical bar on its left side. The 'T' is a simple vertical bar with a horizontal top. The 'E' and 'C' are also simple, blocky shapes. The 'H' is a simple vertical bar with a horizontal top.

تهیه و توزیع قطعات الکترونیک

Page Copy (2)

By using Page Copy (2), data in a page can be copied to another page after the data has been read out. When the block address changes (increments) this sequenced has to be started from the beginning.

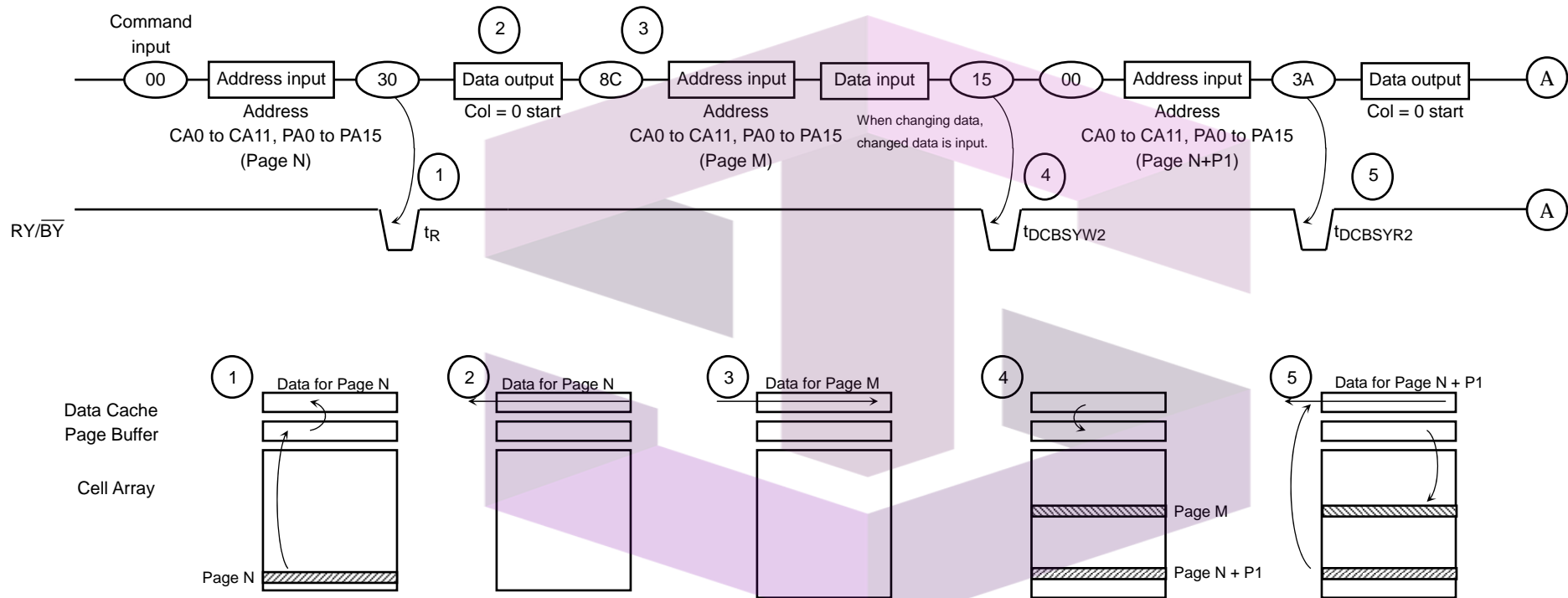

Page Copy (2) operation is as following.

- 1 Data for Page N is transferred to the Data Cache.
- 2 Data for Page N is read out.
- 3 Copy Page address M is input and if the data needs to be changed, changed data is input.
- 4 Data Cache for Page M is transferred to the Page Buffer.
- 5 After the Ready state, Data for Page N + P1 is output from the Data Cache while the data of Page M is being programmed.

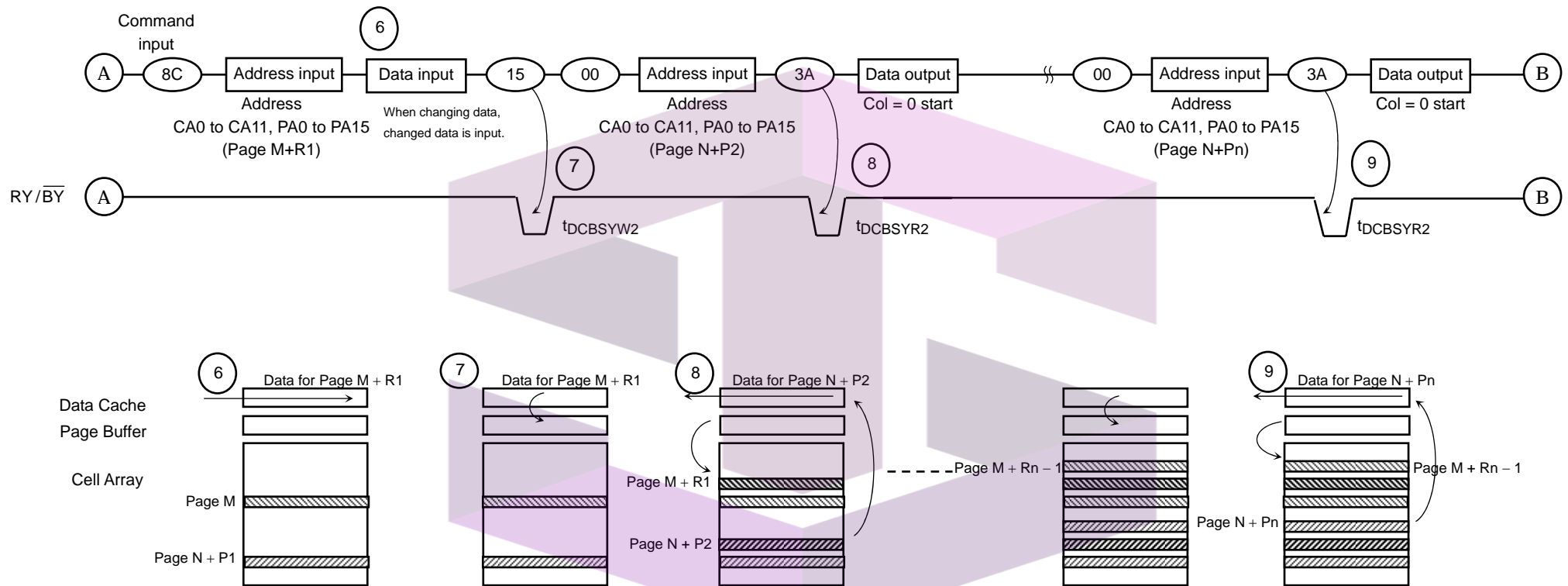

- 6 Copy Page address (M + R1) is input and if the data needs to be changed, changed data is input.
- 7 After programming of page M is completed, Data Cache for Page M + R1 is transferred to the Page Buffer.
- 8 By the 15h command, the data in the Page Buffer is programmed to Page M + R1. Data for Page N + P2 is transferred to the Data cache.
- 9 The data in the Page Buffer is programmed to Page M + Rn - 1. Data for Page N + Pn is transferred to the Data Cache.

تهیه و توزیع قطعات الکترونیک

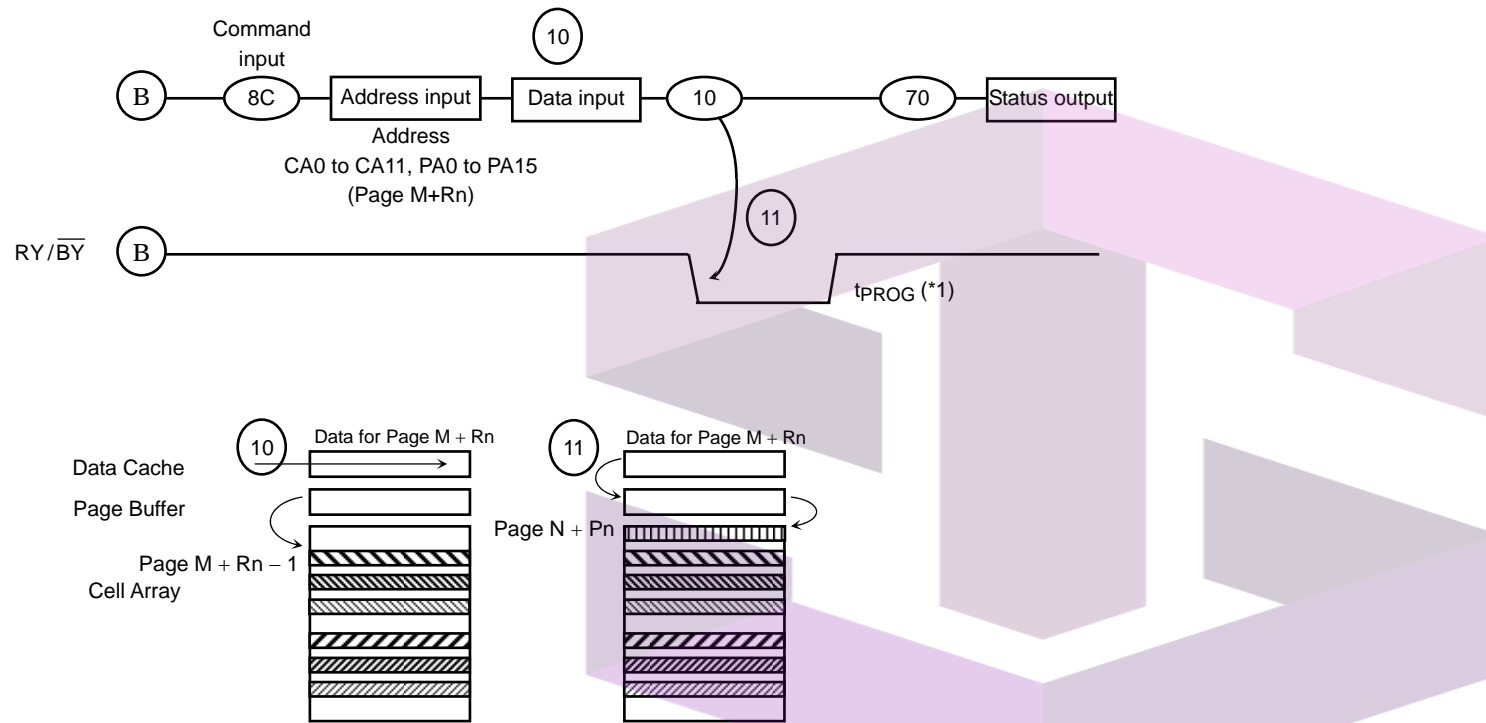

- 10 Copy Page address (M + Rn) is input and if the data needs to be changed, changed data is input.
- 11 By issuing the 10h command, the data in the Page Buffer is programmed to Page M + Rn.

(\*1) Since the last page programming by the 10h command is initiated after the previous cache program, the  $t_{PROG}$  here will be expected as the following,  
 $t_{PROG} = t_{PROG} \text{ of the last page} + t_{PROG} \text{ of the previous page} - (\text{command input cycle} + \text{address input cycle} + \text{data output/input cycle time of the last page})$

NOTE) This operation needs to be executed within District-0 or District-1.

Data input is required only if previous data output needs to be altered.

If the data has to be changed, locate the desired address with the column and page address input after the 8Ch command, and change only the data that needs to be changed.

If the data does not have to be changed, data input cycles are not required.

Make sure  $\overline{WP}$  is held to High level when Page Copy (2) operation is performed.

Also make sure the Page Copy operation is terminated with 8Ch-10h command sequence

Multi Page Copy (2)

By using Multi Page Copy (2), data in two pages can be copied to another pages after the data has been read out. When the each block address changes (increments) this sequenced has to be started from the beginning. Same page address (PA0 to PA5) within two districts has to be selected.

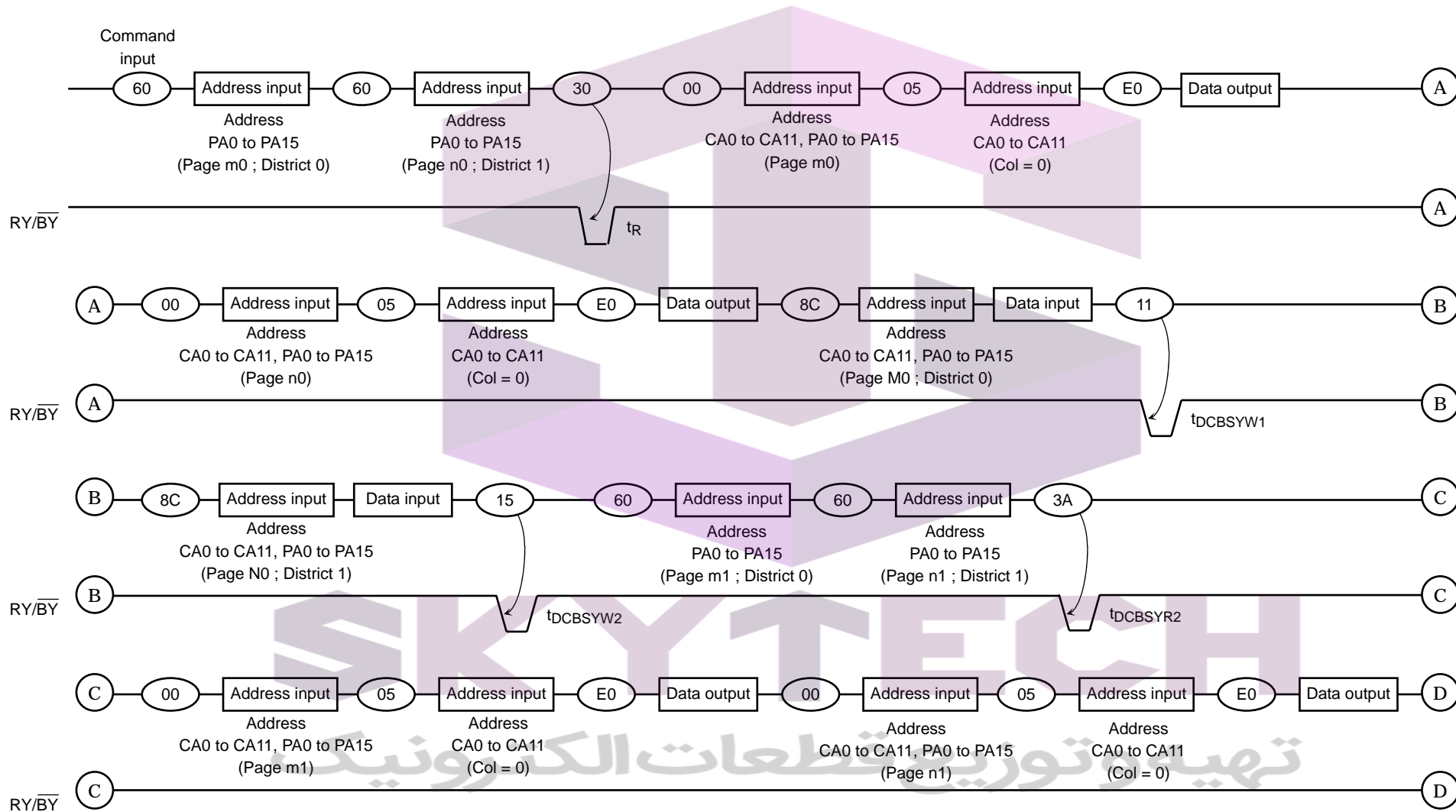

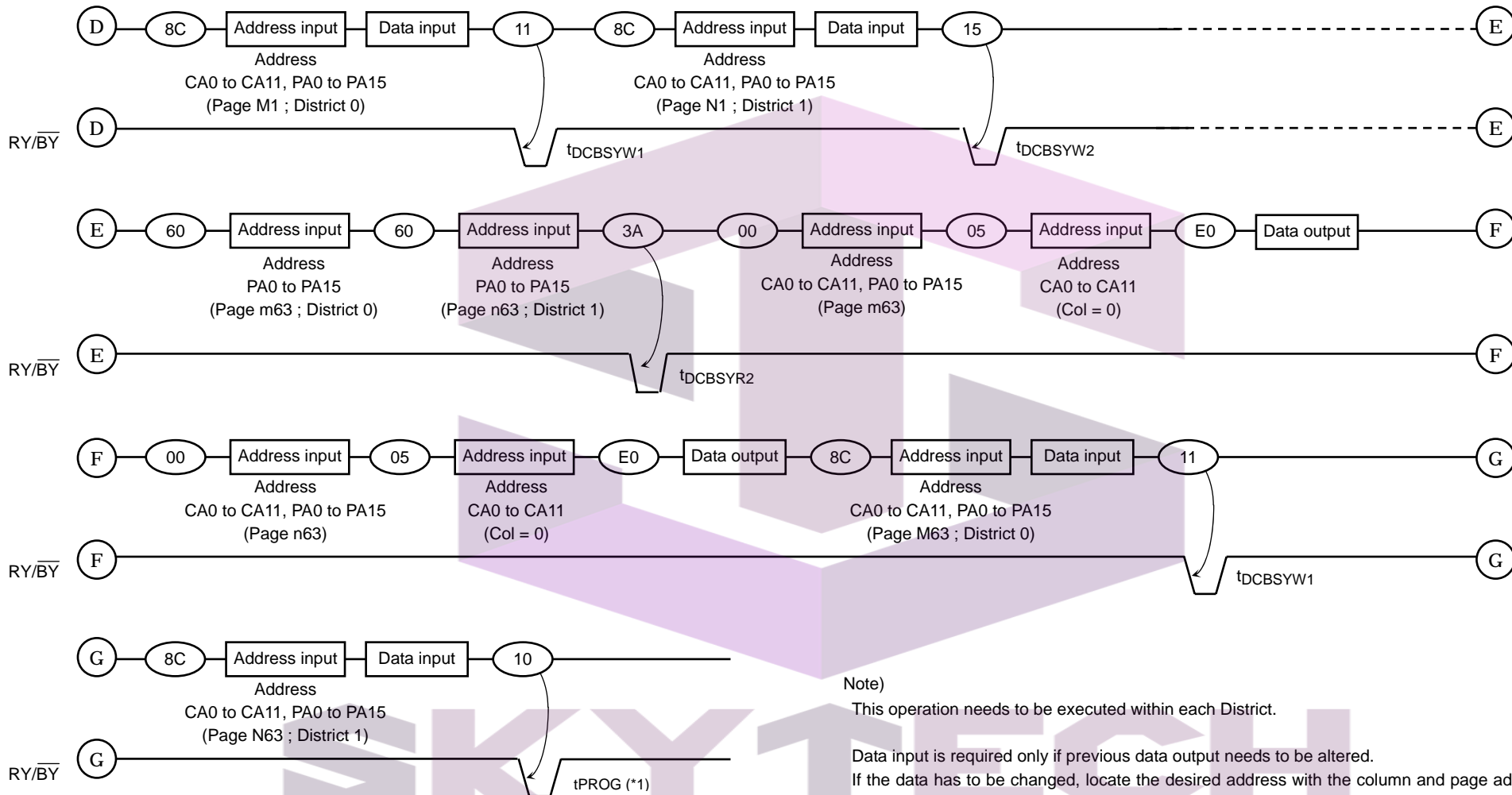

**Note)**

This operation needs to be executed within each District.

Data input is required only if previous data output needs to be altered.

If the data has to be changed, locate the desired address with the column and page address input after the 8Ch command, and change only the data that needs to be changed.

If the data does not have to be changed, data input cycles are not required.

Make sure  $\overline{WP}$  is held to High level when Multi Page Copy (2) operation is performed.

Also make sure the Multi Page Copy operation is terminated with 8Ch-10h command sequence

(\*1)  $t_{PROG}$ : Since the last page programming by 10h command is initiated after the previous cache program, the  $t_{PROG}$  during cache programming is given by the following equation.

$$t_{PROG} = t_{PROG} \text{ of the last page} + t_{PROG} \text{ of the previous page-A}$$

A = (command input cycle + address input cycle + data output/input cycle time of the last page)

If "A" exceeds the  $t_{PROG}$  of previous page,  $t_{PROG}$  of the last page is  $t_{PROG} \text{ max}$ .

Auto Block Erase

The Auto Block Erase operation starts on the rising edge of  $\overline{WE}$  after the Erase Start command “D0h” which follows the Erase Setup command “60h”. This two-cycle process for Erase operations acts as an extra layer of protection from accidental erasure of data due to external noise. The device automatically executes the Erase and Verify operations.

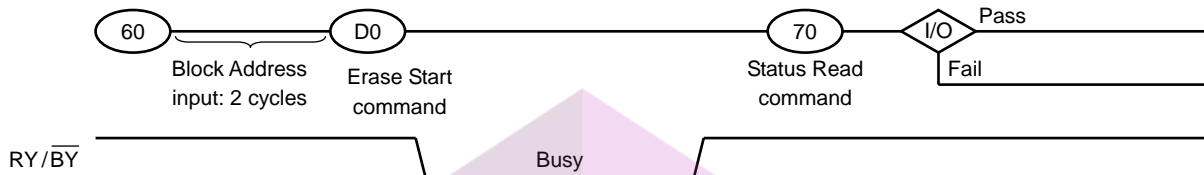

Multi Block Erase

The Multi Block Erase operation starts by selecting two block addresses before D0h command as in below diagram. The device automatically executes the Erase and Verify operations and the result can be monitored by checking the status by 71h status read command. For details on 71h status read command, refer to section “Multi Page Program with Data Cache”.

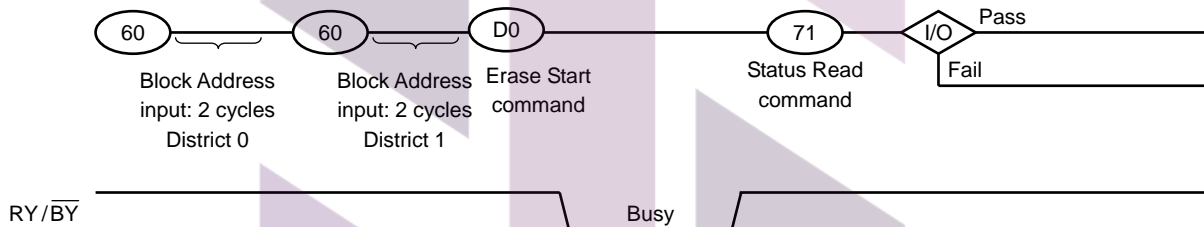

Internal addressing in relation with the Districts

To use Multi Block Erase operation, the internal addressing should be considered in relation with the District.

- The device consists from 2 Districts.
- Each District consists from 512 erase blocks.
- The allocation rule is follows.
  - District 0: Block 0, Block 2, Block 4, Block 6,..., Block 1022
  - District 1: Block 1, Block 3, Block 5, Block 7,..., Block 1023

Address input restriction for the Multi Block Erase

There are following restrictions in using Multi Block Erase

(Restriction)

Maximum one block should be selected from each District.

For example;

(60) [District 0] (60) [District 1] (D0)

(Acceptance)

There is no order limitation of the District for the address input.

For example, following operation is accepted;

(60) [District 1] (60) [District 0] (D0)

It requires no mutual address relation between the selected blocks from each District.

Make sure to terminate the operation with D0h command. If the operation needs to be terminated before D0h command input, input the FFh reset command to terminate the operation.



ID Read

The device contains ID codes which can be used to identify the device type, the manufacturer, and features of the device. The ID codes can be read out under the following timing conditions:

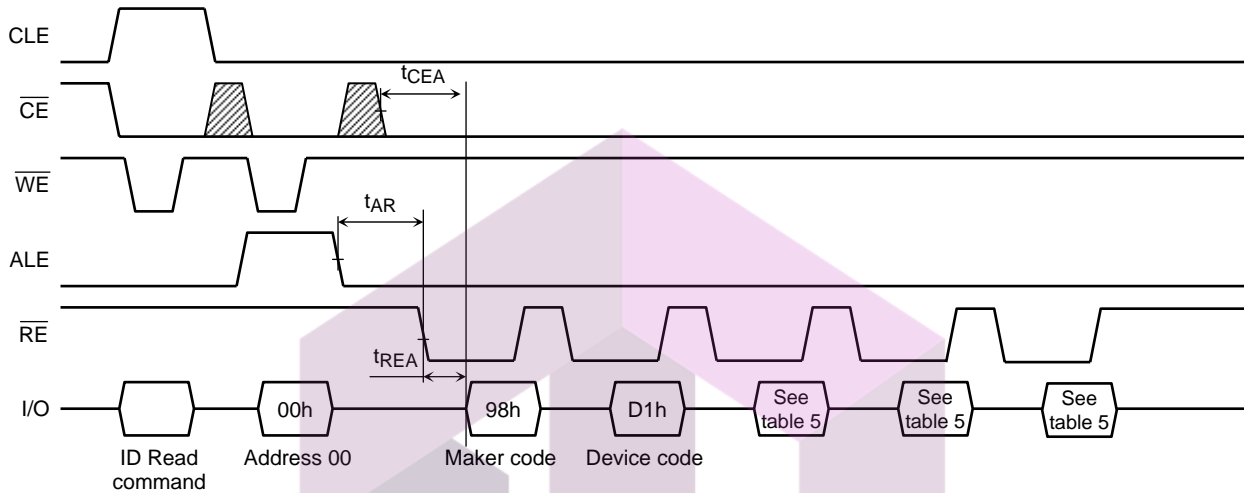

Table 5. Code table

	Description	I/O8	I/O7	I/O6	I/O5	I/O4	I/O3	I/O2	I/O1	Hex Data
1st Data	Maker Code	1	0	0	1	1	0	0	0	98h
2nd Data	Device Code	1	1	0	1	0	0	0	1	D1h
3rd Data	Chip Number, Cell Type	—	—	—	—	—	—	—	—	See table
4th Data	Page Size, Block Size,	—	—	—	—	—	—	—	—	See table
5th Data	Plane Number	—	—	—	—	—	—	—	—	See table

3rd Data

	Description	I/O8	I/O7	I/O6	I/O5	I/O4	I/O3	I/O2	I/O1
Internal Chip Number	1							0	0
	2							0	1
	4							1	0
	8							1	1
Cell Type	2 level cell						0	0	
	4 level cell						0	1	
	8 level cell						1	0	
	16 level cell						1	1	

تهیه و توزیع قطعات الکترونیک

4th Data

	Description	I/O8	I/O7	I/O6	I/O5	I/O4	I/O3	I/O2	I/O1
Page Size (without redundant area)	1 KB							0	0
	2 KB							0	1
	4 KB							1	0
	8 KB							1	1
Block Size (without redundant area)	64 KB			0	0				
	128 KB			0	1				
	256 KB			1	0				
	512 KB			1	1				

5th Data

	Description	I/O8	I/O7	I/O6	I/O5	I/O4	I/O3	I/O2	I/O1
Plane Number	1 Plane					0	0		
	2 Plane					0	1		
	4 Plane					1	0		
	8 Plane					1	1		

**SKYTECH**

تهیه و توزیع قطعات الکترونیک

Status Read

The device automatically implements the execution and verification of the Program and Erase operations. The Status Read function is used to monitor the Ready/Busy status of the device, determine the result (pass /fail) of a Program or Erase operation, and determine whether the device is in Protect mode. The device status is output via the I/O port using  $\overline{RE}$  after a “70h” command input. The Status Read can also be used during a Read operation to find out the Ready/Busy status.

The resulting information is outlined in Table 6.

Table 6. Status output table

	Definition	Page Program Block Erase	Cache Program	Read Cache Read
I/O1	Chip Status1 Pass: 0      Fail: 1	Pass/Fail	Pass/Fail	Invalid
I/O2	Chip Status 2 Pass: 0      Fail: 1	Invalid	Pass/Fail	Invalid
I/O3	Not Used	0	0	0
I/O4	Not Used	0	0	0
I/O5	Not Used	0	0	0
I/O6	Page Buffer Ready/Busy Ready: 1      Busy: 0	Ready/Busy	Ready/Busy	Ready/Busy
I/O7	Data Cache Ready/Busy Ready: 1      Busy: 0	Ready/Busy	Ready/Busy	Ready/Busy
I/O8	Write Protect Not Protected :1      Protected: 0	Write Protect	Write Protect	Write Protect

The Pass/Fail status on I/O1 and I/O2 is only valid during a Program/Erase operation when the device is in the Ready state.

**Chip Status 1:**

During a Auto Page Program or Auto Block Erase operation this bit indicates the pass/fail result.

During a Auto Page Programming with Data Cache operation, this bit shows the pass/fail results of the current page program operation, and therefore this bit is only valid when I/O6 shows the Ready state.

**Chip Status 2:**

This bit shows the pass/fail result of the previous page program operation during Auto Page Programming with Data Cache. This status is valid when I/O7 shows the Ready State.

The status output on the I/O6 is the same as that of I/O7 if the command input just before the 70h is not 15h or 31h.



تهیه و توزیع قطعات الکترونیک

An application example with multiple devices is shown in the figure below.

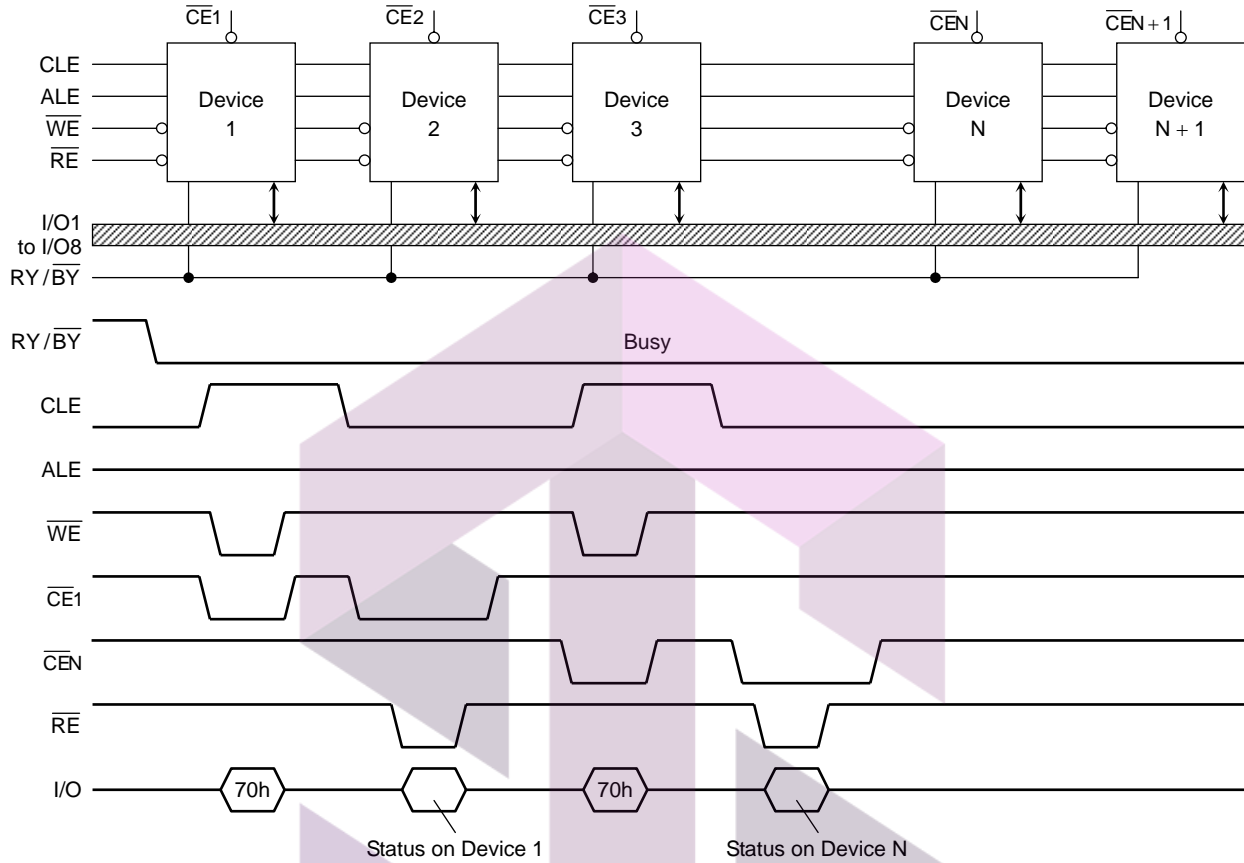

System Design Note: If the RY /  $\overline{\text{BY}}$  pin signals from multiple devices are wired together as shown in the diagram, the Status Read function can be used to determine the status of each individual device.

**Reset**

The Reset mode stops all operations. For example, in case of a Program or Erase operation, the internally generated voltage is discharged to 0 volt and the device enters the Wait state.

Reset during a Cache Program/Page Copy may not just stop the most recent page program but it may also stop the previous program to a page depending on when the FF reset is input.

The response to a "FFh" Reset command input during the various device operations is as follows:

When a Reset (FFh) command is input during programming

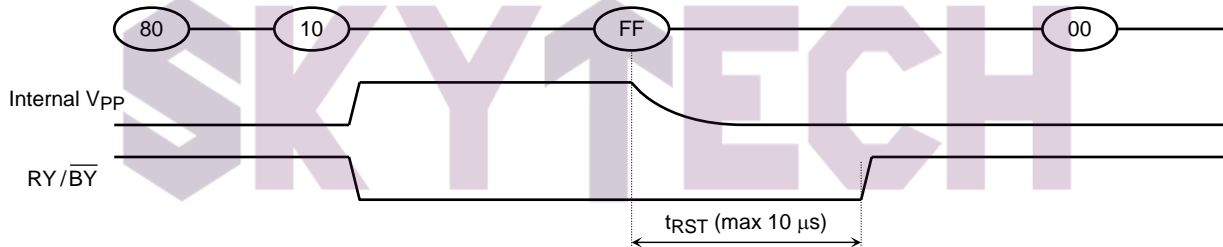

تهیه و توزیع قطعات الکترونیک

When a Reset (FFh) command is input during erasing

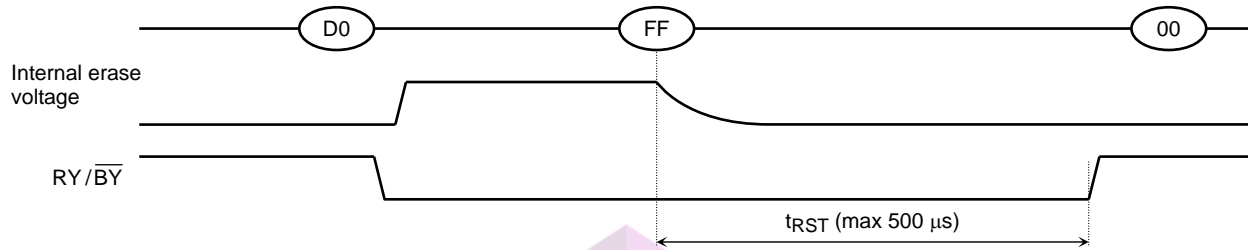

When a Reset (FFh) command is input during Read operation

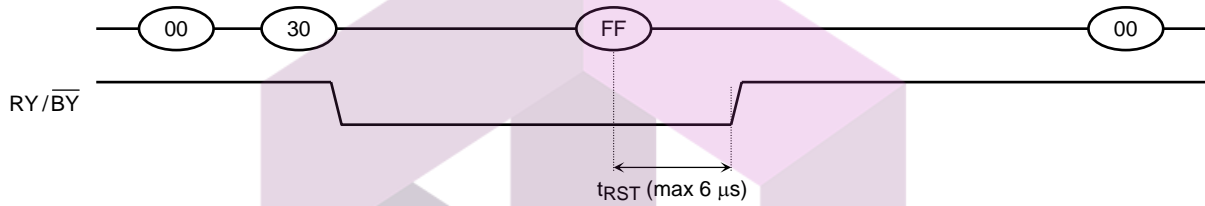

When a Reset (FFh) command is input during Ready

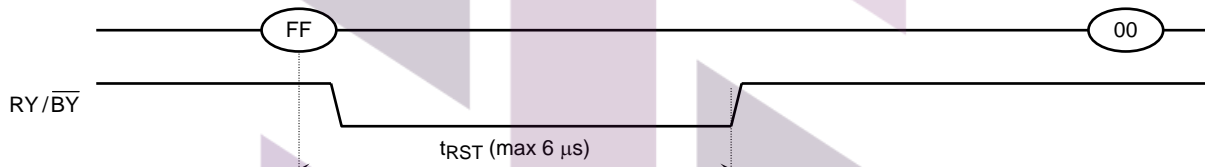

When a Status Read command (70h) is input after a Reset

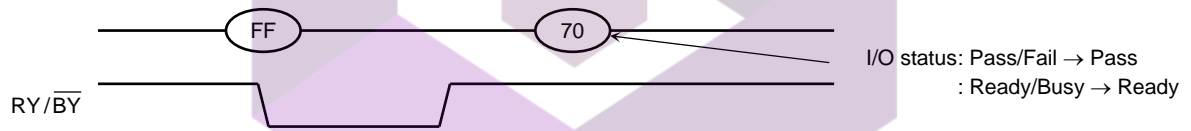

When two or more Reset commands are input in succession

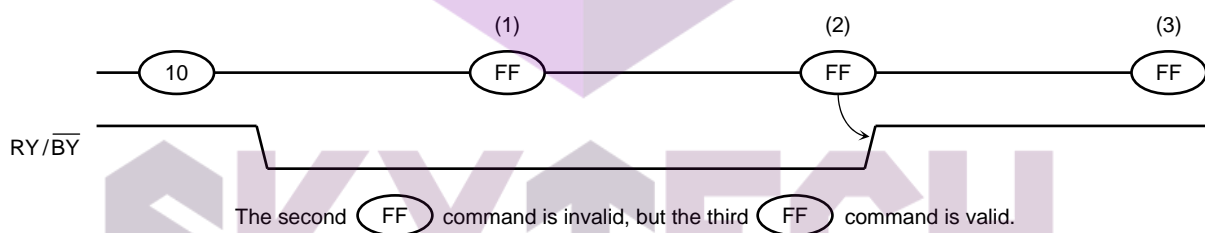

تهیه و توزیع قطعات الکترونیک

**APPLICATION NOTES AND COMMENTS**

(1) Power-on/off sequence:

The timing sequence shown in the figure below is necessary for the power-on/off sequence. The device internal initialization starts after the power supply reaches an appropriate level in the power on sequence. During the initialization the device Ready/Busy signal indicates the Busy state as shown in the figure below. In this time period, the acceptable commands are FFh or 70h. The  $\overline{WP}$  signal is useful for protecting against data corruption at power-on/off.

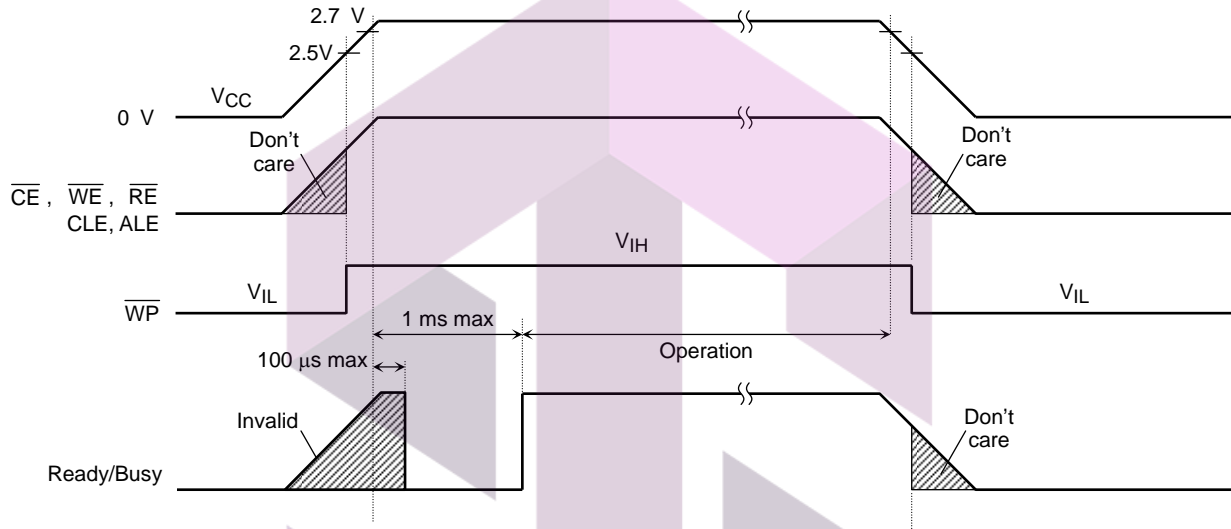

(2) Power-on Reset

The following sequence is necessary because some input signals may not be stable at power-on.

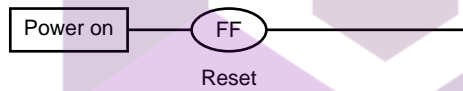

(3) Prohibition of unspecified commands

The operation commands are listed in Table 3. Input of a command other than those specified in Table 3 is prohibited. Stored data may be corrupted if an unknown command is entered during the command cycle.

(4) Restriction of commands while in the Busy state

During the Busy state, do not input any command except 70h(71h) and FFh.

SKYTECH

تهیه و توزیع قطعات الکترونیک

(5) Acceptable commands after Serial Input command “80h”

Once the Serial Input command “80h” has been input, do not input any command other than the Column Address Change in Serial Data Input command “85h”, Auto Program command “10h”, Multi Page Program command “11h”, Auto Program with Data Cache Command “15h”, or the Reset command “FFh”.

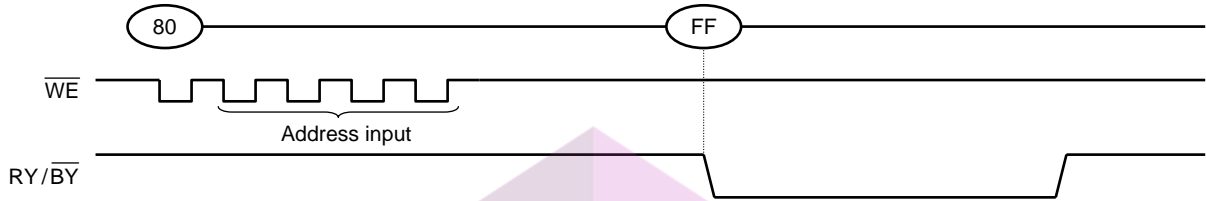

If a command other than “85h”, “10h”, “11h”, “15h” or “FFh” is input, the Program operation is not performed and the device operation is set to the mode which the input command specifies.

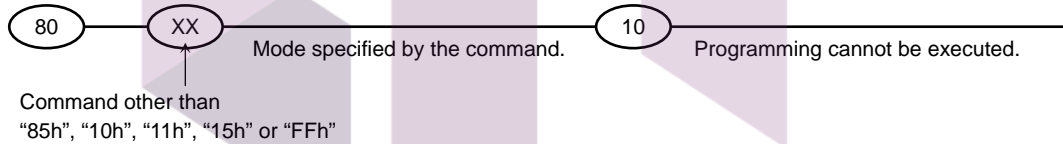

(6) Addressing for program operation

Within a block, the pages must be programmed consecutively from the LSB (least significant bit) page of the block to MSB (most significant bit) page of the block. Random page address programming is prohibited.

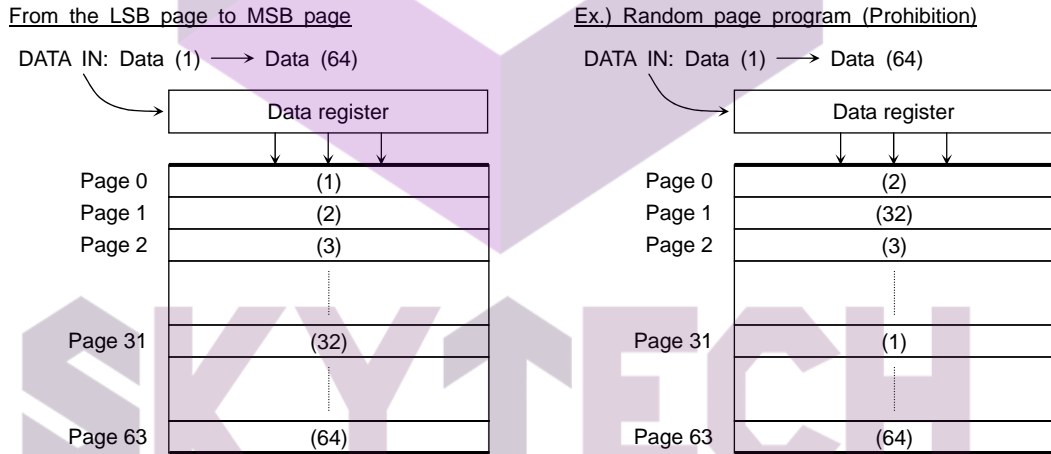

تهیه و توزیع قطعات الکترونیک

(7) Status Read during a Read operation

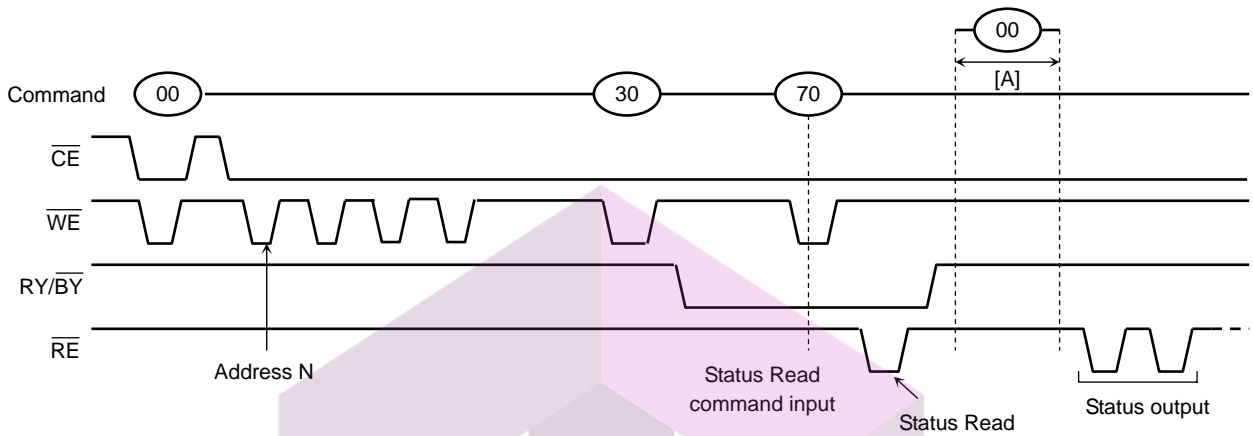

The device status can be read out by inputting the Status Read command “70h” in Read mode. Once the device has been set to Status Read mode by a “70h” command, the device will not return to Read mode unless the Read command “00h” is inputted during [A]. If the Read command “00h” is inputted during [A], Status Read mode is reset, and the device returns to Read mode. In this case, data output starts automatically from address N and address input is unnecessary

(8) Auto programming failure

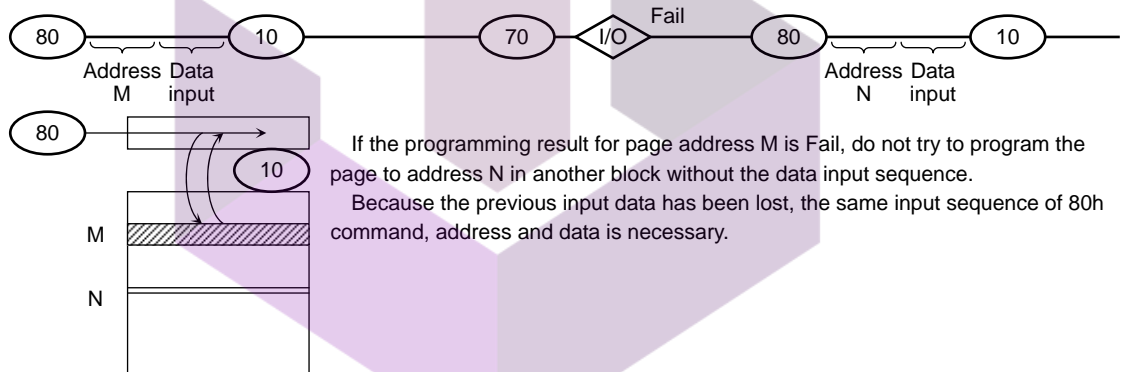

(9) RY/BY : termination for the Ready/Busy pin (RY/BY)

A pull-up resistor needs to be used for termination because the RY/BY buffer consists of an open drain circuit.

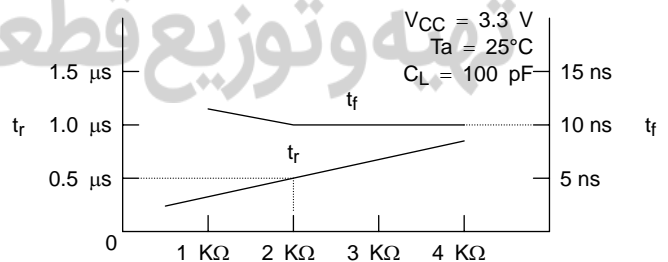
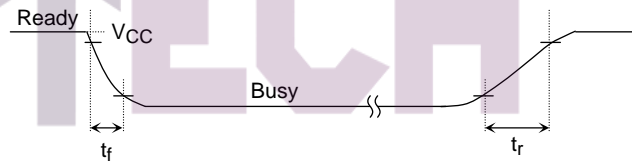
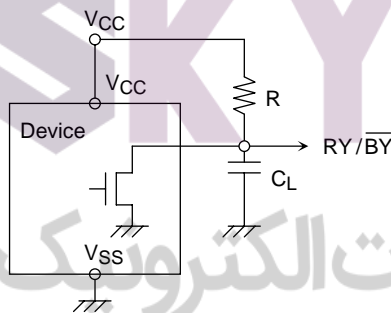

This data may vary from device to device. We recommend that you use this data as a reference when selecting a resistor value.



(10) Note regarding the  $\overline{WP}$  signal

The Erase and Program operations are automatically reset when  $\overline{WP}$  goes Low. The operations are enabled and disabled as follows:

Enable Programming

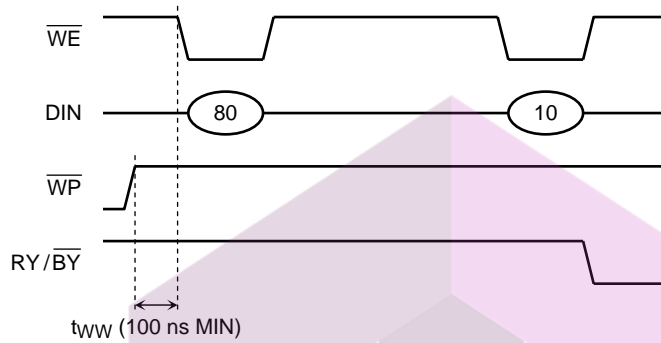

Disable Programming

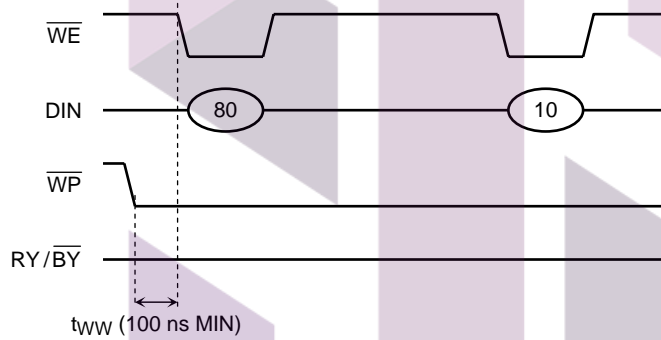

Enable Erasing

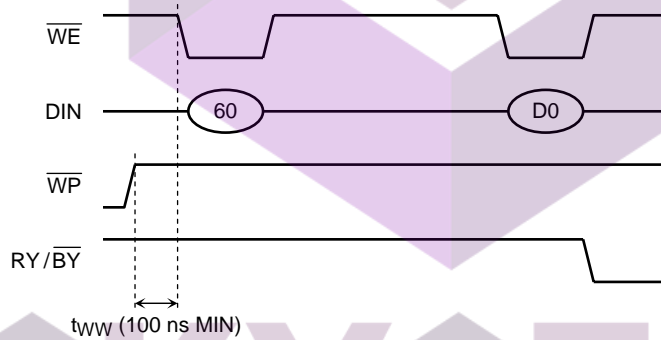

Disable Erasing

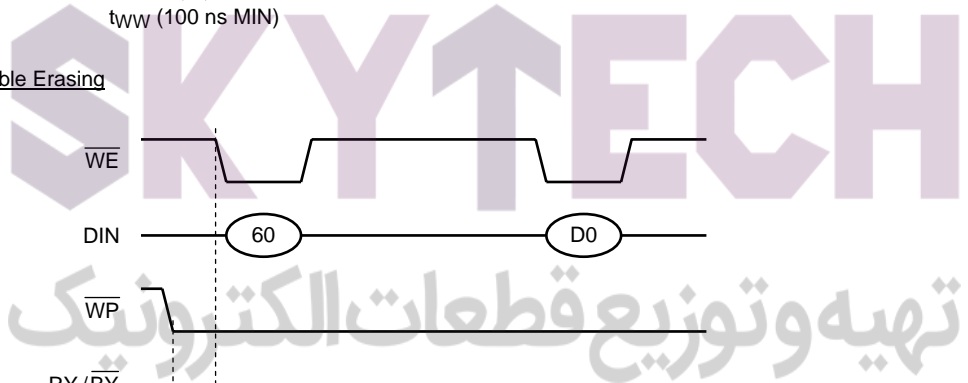
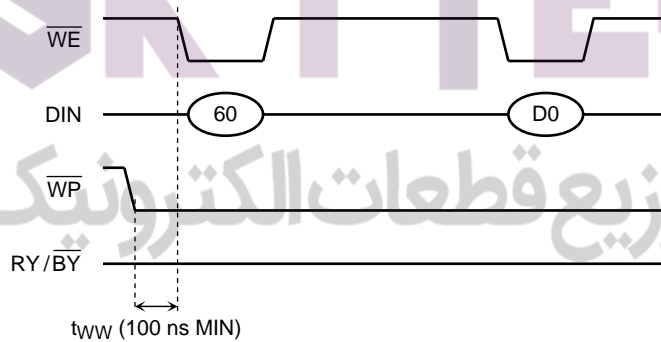

(11) When five address cycles are input

Although the device may read in a fifth address, it is ignored inside the chip.

Read operation

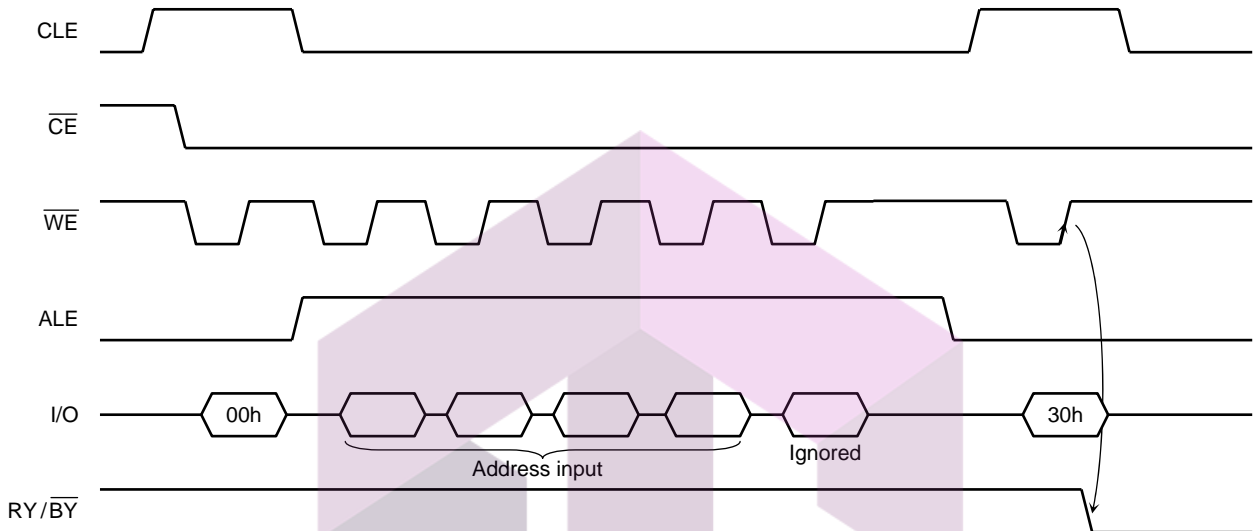

Program operation

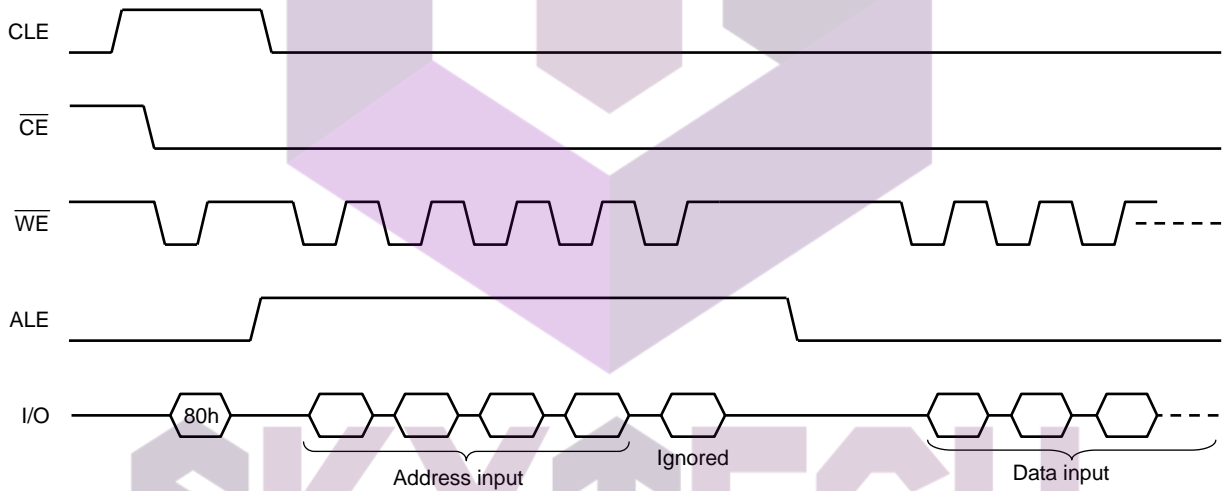

تهیه و توزیع قطعات الکترونیک

(12) Several programming cycles on the same page (Partial Page Program)

Each segment can be programmed individually as follows:

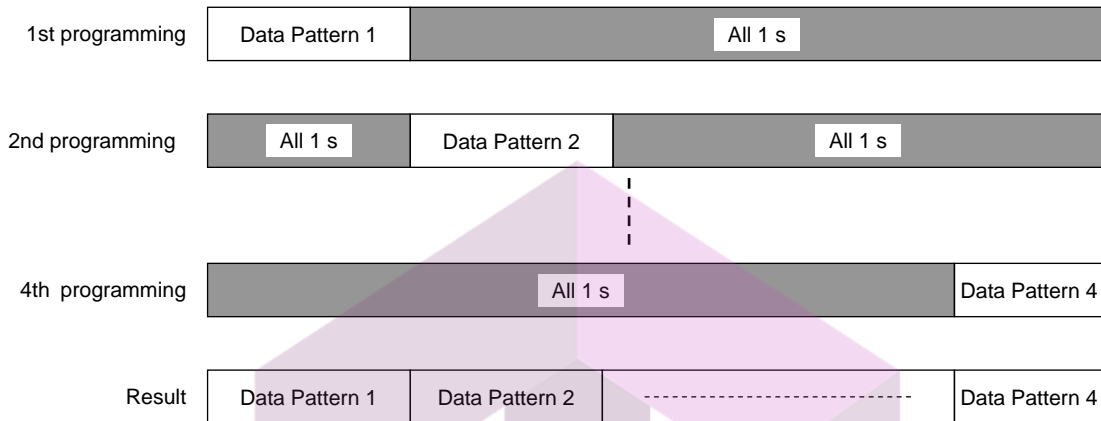

SKYTECH

تهیه و توزیع قطعات الکترونیک

(13) Invalid blocks (bad blocks)

The device occasionally contains unusable blocks. Therefore, the following issues must be recognized:

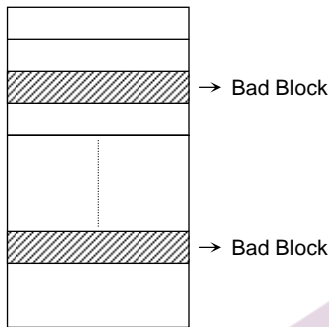

Please do not perform an erase operation to bad blocks. It may be impossible to recover the bad block information if the information is erased.

Check if the device has any bad blocks after installation into the system. Refer to the test flow for bad block detection. Bad blocks which are detected by the test flow must be managed as unusable blocks by the system.

A bad block does not affect the performance of good blocks because it is isolated from the bit lines by select gates.

The number of valid blocks over the device lifetime is as follows:

	MIN	TYP.	MAX	UNIT
Valid (Good) Block Number	1004	—	1024	Block

**Bad Block Test Flow**

Regarding invalid blocks, bad block mark is in either the 1st or the 2nd page.

Read Check :  
Read either column 0 or 2048 of the 1st page or the 2nd page of each block. If the data of the column is not FF (Hex), define the block as a bad block.

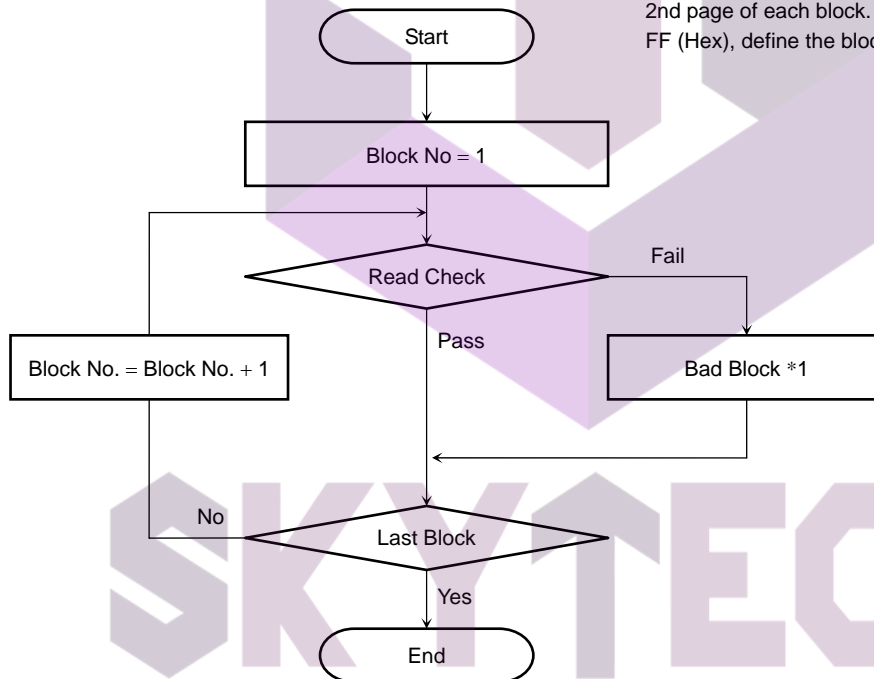

\*1: No erase operation is allowed to detected bad blocks



(14) Failure phenomena for Program and Erase operations

The device may fail during a Program or Erase operation.

The following possible failure modes should be considered when implementing a highly reliable system.

FAILURE MODE		DETECTION AND COUNTERMEASURE SEQUENCE
Block	Erase Failure	Status Read after Erase → Block Replacement
Page	Programming Failure	Status Read after Program → Block Replacement
Single Bit	Programming Failure "1 to 0"	ECC

- ECC: Error Correction Code. 1 bit correction per 512 Bytes is necessary.
- Block Replacement

Program

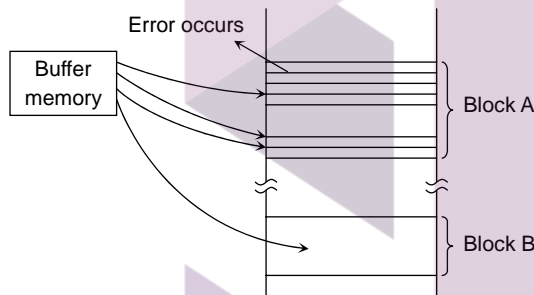

When an error happens in Block A, try to reprogram the data into another Block (Block B) by loading from an external buffer. Then, prevent further system accesses to Block A ( by creating a bad block table or by using another appropriate scheme).

Erase

When an error occurs during an Erase operation, prevent future accesses to this bad block (again by creating a table within the system or by using another appropriate scheme).

- (15) Do not turn off the power before write/erase operation is complete. Avoid using the device when the battery is low. Power shortage and/or power failure before write/erase operation is complete will cause loss of data and/or damage to data.
- (16) The number of valid blocks is on the basis of single plane operations, and this may be decreased with two plane operations.

SKYTECH

تهیه و توزیع قطعات الکترونیک

(17) Reliability Guidance

This reliability guidance is intended to notify some guidance related to using NAND flash with 1 bit ECC for each 512 bytes. For detailed reliability data, please refer to TOSHIBA's reliability note. Although random bit errors may occur during use, it does not necessarily mean that a block is bad. Generally, a block should be marked as bad when a program status failure or erase status failure is detected. The other failure modes may be recovered by a block erase. ECC treatment for read data is mandatory due to the following Data Retention and Read Disturb failures.

- **Write/Erase Endurance**

Write/Erase endurance failures may occur in a cell, page, or block, and are detected by doing a status read after either an auto program or auto block erase operation. The cumulative bad block count will increase along with the number of write/erase cycles.

- **Data Retention**

The data in memory may change after a certain amount of storage time. This is due to charge loss or charge gain. After block erasure and reprogramming, the block may become usable again.

Here is the combined characteristics image of Write/Erase Endurance and Data Retention.

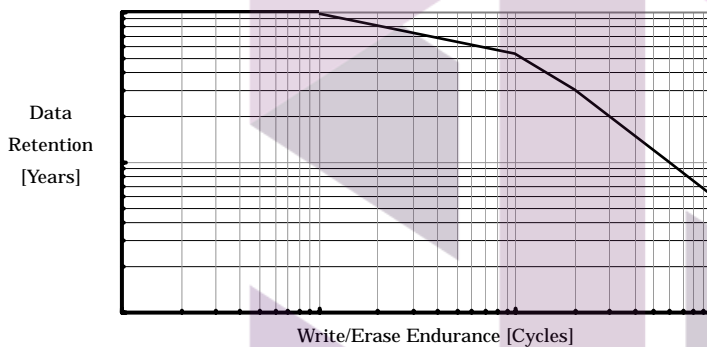

- **Read Disturb**

A read operation may disturb the data in memory. The data may change due to charge gain. Usually, bit errors occur on other pages in the block, not the page being read. After a large number of read cycles (between block erases), a tiny charge may build up and can cause a cell to be soft programmed to another state. After block erasure and reprogramming, the block may become usable again.

SKYTECH

تهیه و توزیع قطعات الکترونیک

**Package Dimensions**

TSOP I 48-P-1220-0.50

Unit : mm

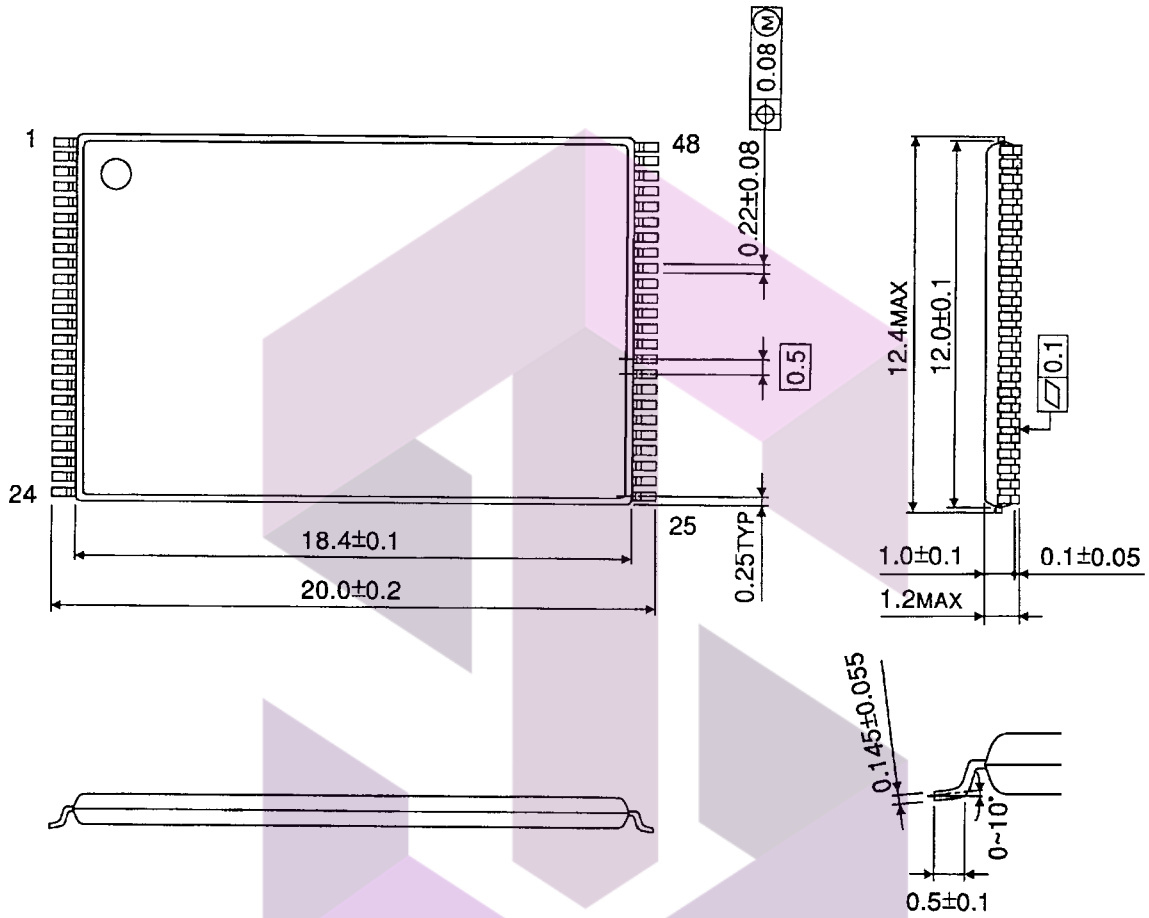

Weight: 0.53g (typ.)

SKYTECH

تهیه و توزیع قطعات الکترونیک

**Revision History**

Date	Rev.	Description
2008-11-20	1.00	Original version
2009-01-07	1.01	Description for PSL is added.
2009-03-09	1.02	Description for PSL is eliminated.
		Descriptions of APPLICATION NOTES AND COMMENTS (5) and (7) are changed.
2009-07-03	1.03	tRHOH is changed from 25ns to 22ns.
2009-07-09	1.04	Modified "FEATURES". Revised "APPLICATION NOTES AND COMMENTS" (14). tRST is changed.
2010-01-25	1.05	Deleted an invalid description at Page 30. Deleted Confidential notation. Changed "RESTRICTIONS ON PRODUCT USE".
2010-05-21	1.06	Corrected TIMING DIAGRAM of ID Read.
2010-07-13	1.07	Deleted TENTATIVE notation.
2011-03-01	1.08	tR is changed.

The logo for SKYTECH, featuring a stylized 'S' and 'T' in a purple and grey color scheme, with the word 'SKYTECH' in a bold, sans-serif font below it.

تهیه و توزیع قطعات الکترونیک



**RESTRICTIONS ON PRODUCT USE**

- Toshiba Corporation, and its subsidiaries and affiliates (collectively "TOSHIBA"), reserve the right to make changes to the information in this document, and related hardware, software and systems (collectively "Product") without notice.
- This document and any information herein may not be reproduced without prior written permission from TOSHIBA. Even with TOSHIBA's written permission, reproduction is permissible only if reproduction is without alteration/omission.
- Though TOSHIBA works continually to improve Product's quality and reliability, Product can malfunction or fail. Customers are responsible for complying with safety standards and for providing adequate designs and safeguards for their hardware, software and systems which minimize risk and avoid situations in which a malfunction or failure of Product could cause loss of human life, bodily injury or damage to property, including data loss or corruption. Before customers use the Product, create designs including the Product, or incorporate the Product into their own applications, customers must also refer to and comply with (a) the latest versions of all relevant TOSHIBA information, including without limitation, this document, the specifications, the data sheets and application notes for Product and the precautions and conditions set forth in the "TOSHIBA Semiconductor Reliability Handbook" and (b) the instructions for the application with which the Product will be used with or for. Customers are solely responsible for all aspects of their own product design or applications, including but not limited to (a) determining the appropriateness of the use of this Product in such design or applications; (b) evaluating and determining the applicability of any information contained in this document, or in charts, diagrams, programs, algorithms, sample application circuits, or any other referenced documents; and (c) validating all operating parameters for such designs and applications. **TOSHIBA ASSUMES NO LIABILITY FOR CUSTOMERS' PRODUCT DESIGN OR APPLICATIONS.**
- Product is intended for use in general electronics applications (e.g., computers, personal equipment, office equipment, measuring equipment, industrial robots and home electronics appliances) or for specific applications as expressly stated in this document. Product is neither intended nor warranted for use in equipment or systems that require extraordinarily high levels of quality and/or reliability and/or a malfunction or failure of which may cause loss of human life, bodily injury, serious property damage or serious public impact ("Unintended Use"). Unintended Use includes, without limitation, equipment used in nuclear facilities, equipment used in the aerospace industry, medical equipment, equipment used for automobiles, trains, ships and other transportation, traffic signaling equipment, equipment used to control combustions or explosions, safety devices, elevators and escalators, devices related to electric power, and equipment used in finance-related fields. Do not use Product for Unintended Use unless specifically permitted in this document.
- Do not disassemble, analyze, reverse-engineer, alter, modify, translate or copy Product, whether in whole or in part.
- Product shall not be used for or incorporated into any products or systems whose manufacture, use, or sale is prohibited under any applicable laws or regulations.
- The information contained herein is presented only as guidance for Product use. No responsibility is assumed by TOSHIBA for any infringement of patents or any other intellectual property rights of third parties that may result from the use of Product. No license to any intellectual property right is granted by this document, whether express or implied, by estoppel or otherwise.
- **ABSENT A WRITTEN SIGNED AGREEMENT, EXCEPT AS PROVIDED IN THE RELEVANT TERMS AND CONDITIONS OF SALE FOR PRODUCT, AND TO THE MAXIMUM EXTENT ALLOWABLE BY LAW, TOSHIBA (1) ASSUMES NO LIABILITY WHATSOEVER, INCLUDING WITHOUT LIMITATION, INDIRECT, CONSEQUENTIAL, SPECIAL, OR INCIDENTAL DAMAGES OR LOSS, INCLUDING WITHOUT LIMITATION, LOSS OF PROFITS, LOSS OF OPPORTUNITIES, BUSINESS INTERRUPTION AND LOSS OF DATA, AND (2) DISCLAIMS ANY AND ALL EXPRESS OR IMPLIED WARRANTIES AND CONDITIONS RELATED TO SALE, USE OF PRODUCT, OR INFORMATION, INCLUDING WARRANTIES OR CONDITIONS OF MERCHANTABILITY, FITNESS FOR A PARTICULAR PURPOSE, ACCURACY OF INFORMATION, OR NONINFRINGEMENT.**
- Do not use or otherwise make available Product or related software or technology for any military purposes, including without limitation, for the design, development, use, stockpiling or manufacturing of nuclear, chemical, or biological weapons or missile technology products (mass destruction weapons). Product and related software and technology may be controlled under the Japanese Foreign Exchange and Foreign Trade Law and the U.S. Export Administration Regulations. Export and re-export of Product or related software or technology are strictly prohibited except in compliance with all applicable export laws and regulations.
- Product is subject to foreign exchange and foreign trade control laws.
- Please contact your TOSHIBA sales representative for details as to environmental matters such as the RoHS compatibility of Product. Please use Product in compliance with all applicable laws and regulations that regulate the inclusion or use of controlled substances, including without limitation, the EU RoHS Directive. TOSHIBA assumes no liability for damages or losses occurring as a result of noncompliance with applicable laws and regulations.

تهيئه وتوزيع قطعات الكترولنيك

# Mouser Electronics

Authorized Distributor

Click to View Pricing, Inventory, Delivery & Lifecycle Information:

Toshiba:

[TC58NVG0S3ETA00](#)



**SKYTECH**

تهیه و توزیع قطعات الکترونیک